

Product Catalogue
Horizontal Formwork

FS multi-form



FS form-scaff

Formwork & Scaffolding
Solutions

We are
WACO



Form-Scaff is South Africa's leading supplier of formwork, falsework and scaffolding to the construction and civil engineering industries. Form-Scaff not only manufactures, hires and sells world-class products, but also provides the design skills, technical advice and support that comes with having 50 years experience and more than 30 branches locally and internationally.

We are Waco International

Form-Scaff is part of Waco International, a focused equipment rental and industrial services business with operations in Africa (South Africa and other sub-Saharan African countries), Australasia (Australia and New Zealand) and the United Kingdom.

The Group provides services in the areas of formwork, shoring and scaffolding, insulation, painting and blasting, hydraulics and suspended access platforms, relocatable modular buildings, portable sanitation products and integrated hygiene services.

Disclaimer:

Copyright in this catalogue vests in Form-Scaff, a division of Waco Africa (Proprietary) Limited ("Form-Scaff") and extends inter alia, to the making of copies in whole or in part without the prior written consent of Form-Scaff.

While every effort has been made to ensure the accuracy of the information in this catalogue, we cannot accept responsibility for any errors which may occur as a result of reliance on the contents of this catalogue and are not liable for any loss of any nature that may be incurred as a result of such reliance. Details of any of the products may change without prior notice.

The customer must ensure that 'good practice' is adopted on site by competent persons and that the products shown in this catalogue are erected, used and stripped in accordance with the relevant Codes of Practice and the OHS Act and Regulations 85 of 1993. This catalogue does not contain any design detail but lists and depicts the items available under this product range. The responsibility for design is the responsibility of the customer.

Note: The colours used in this document are for illustrative purposes only and may differ on actual products

Contents



multi-form

- Page 2** Multi-Form Overview
 - Page 3** General Assembly
 - Page 4** Supportwork - Props
 - Page 6** Trusses & Tri-Pods
 - Page 8** Supportwork - Kwik-Stage
 - Page 10** Beams & Bearers
 - Page 11** Prop Heads
 - Page 14** Guardrails
 - Page 15** Tables
-
- Contact Details**
 - Page 17** Head Office & Branches

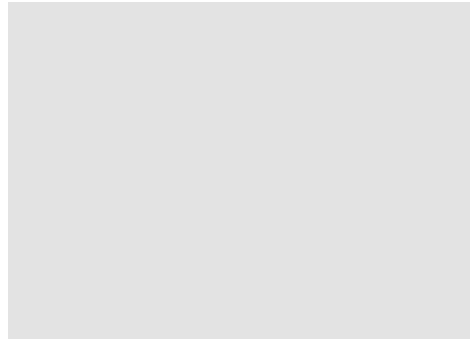
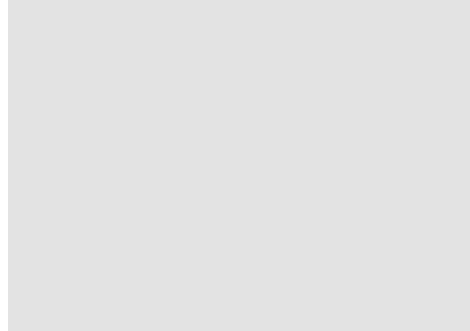



Multi-Form Slabs

Form-Scaff's unique Multi-Form slab range provides contractors with a choice of main and secondary bearers that can be used in a number of ways.

Form-Scaff's unique Kwik-Strip Drop-Head allows the Multi-Form deck to be stripped after a couple of days, thus optimising equipment usage on site. Table-Forms are also available for larger, repetitive projects.

System Features

- Galvanised steel bearers and beams for longevity.
- Table-Forms available.
- Propping between 1.8m and 10.5m.
- High quality WISA-Form plywood.
- Superb concrete finishes.



General Assembly

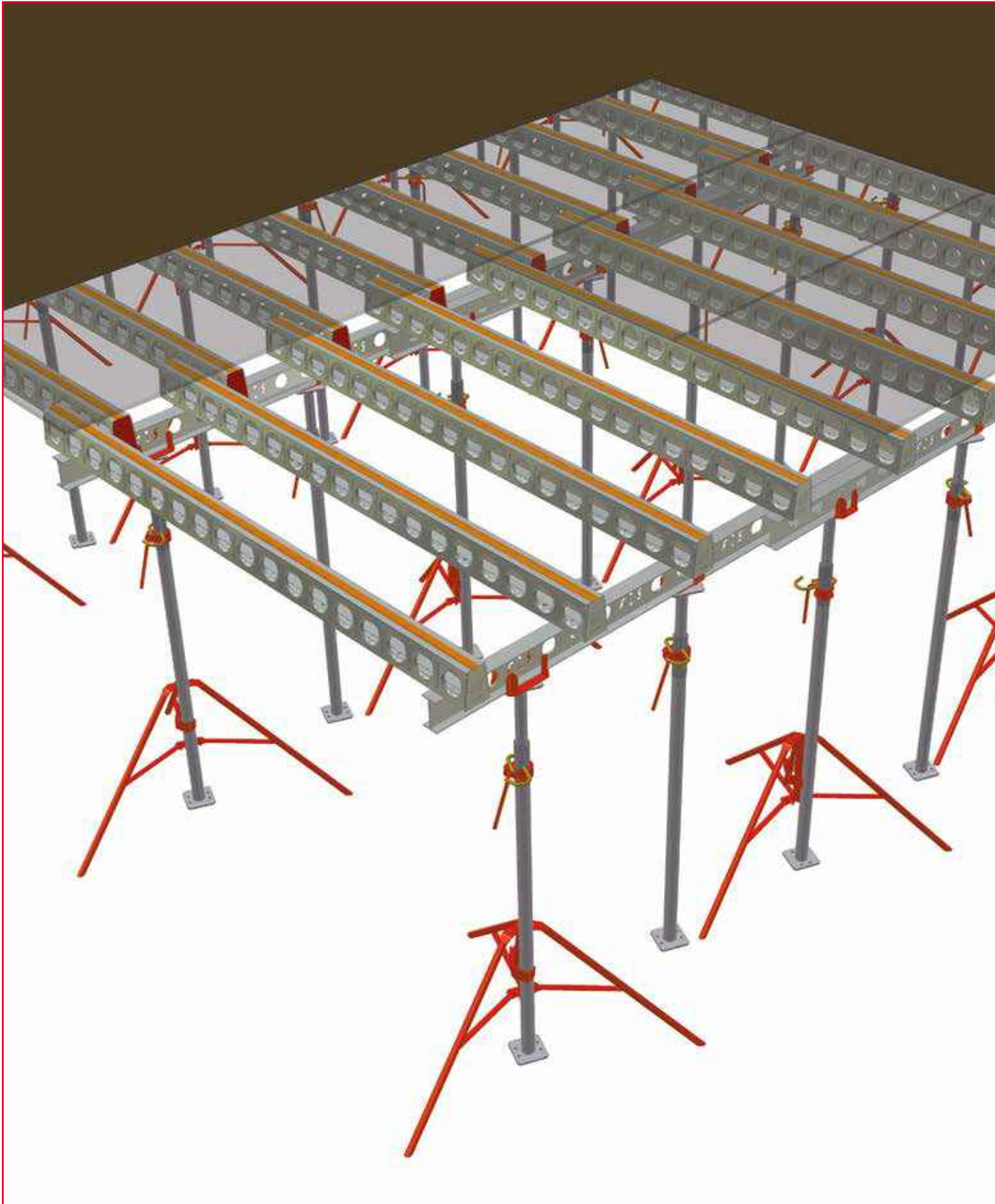

Supportwork - Props

BS Props

BS Props are used to support the Multi-Form System to a propping height of 4000mm. The galvanised Props is the preferred system to be used with the Multi-Form System.

CODE	DESCRIPTION	MASS(kg)
5105007	BS-0 PROP INNER	8.6
5105008	BS-0 PROP OUTER	11.1
1520002	BS-1 PROP INNER	11.8
1520003	BS-1 PROP OUTER	16.4
1520006	BS-2 PROP COMPLETE	29.8

Prop Heights

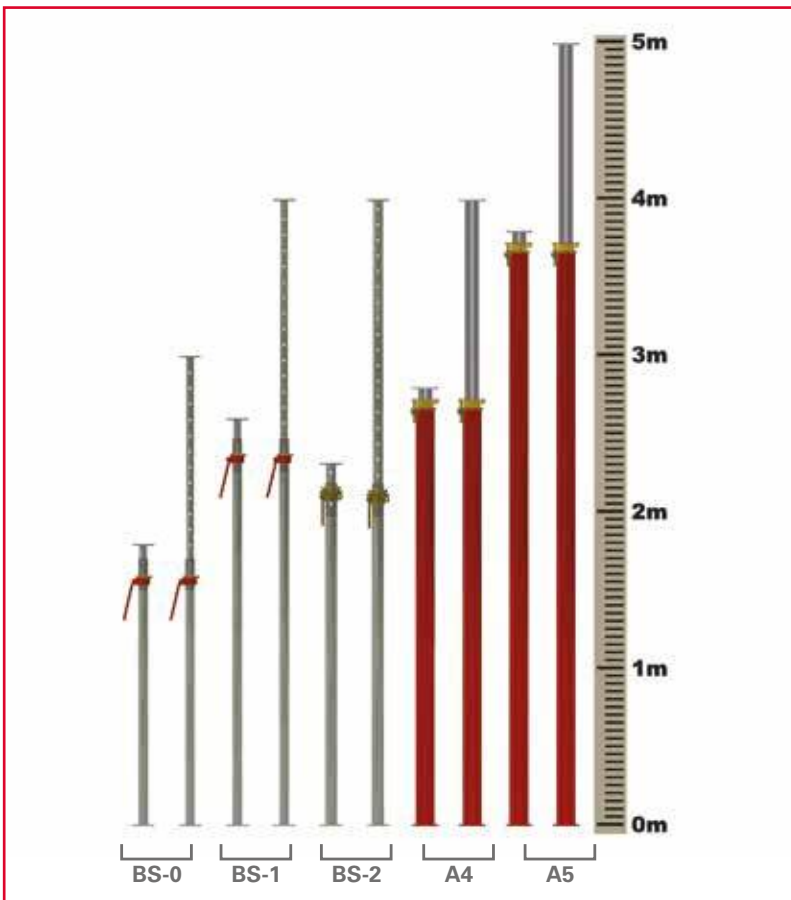

Alu-Up Props

Single Alu-Up Props are used to support the Multi-Form System to a propping height of 5000mm.

CODE	DESCRIPTION	MASS(kg)
5105199	ALU-UP 4 PROP	25.0
5105200	ALU-UP 5 PROP	29.3

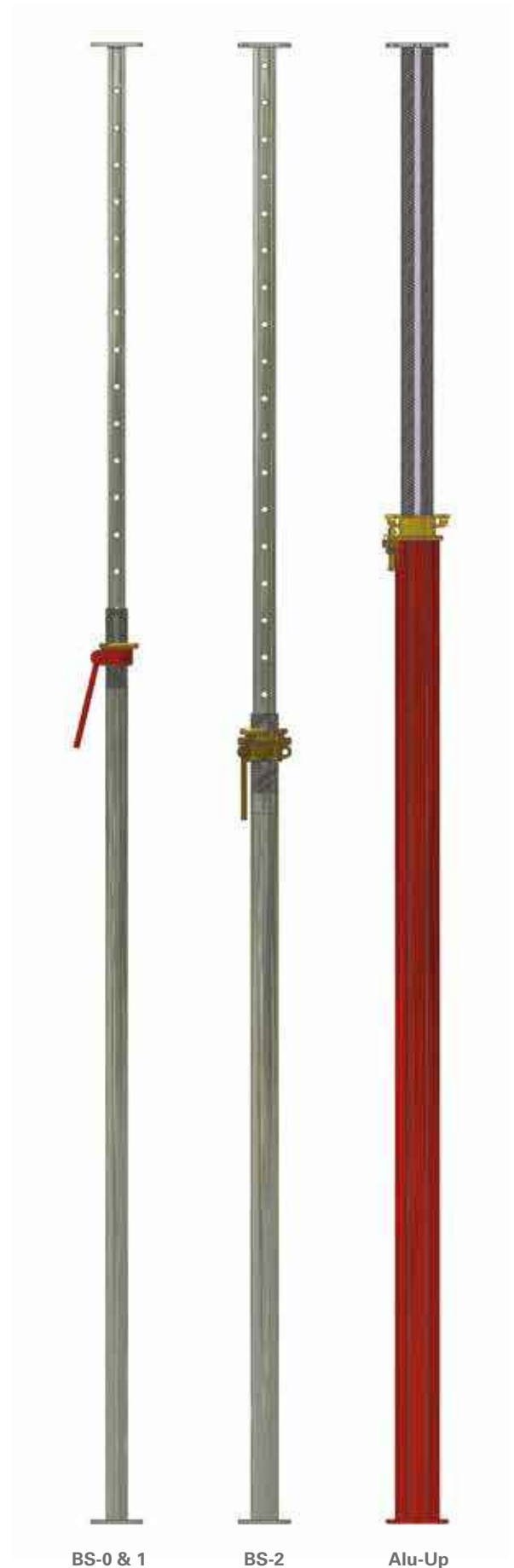

Alu-Up Prop Stubs and Extensions

Alu-Up Prop Extensions are used to extend the propping height from 5000mm to 6150mm. The Stubs are bolted to the bottom of all Props to act as a hammering piece.

CODE	DESCRIPTION	MASS(kg)
5105205	ALU-UP EXTENSION 1000	12.2
5105204	ALU-UP EXTENSION 500	7.5
5105210	ALU-UP STUB 150	4.3



Application - BS Props

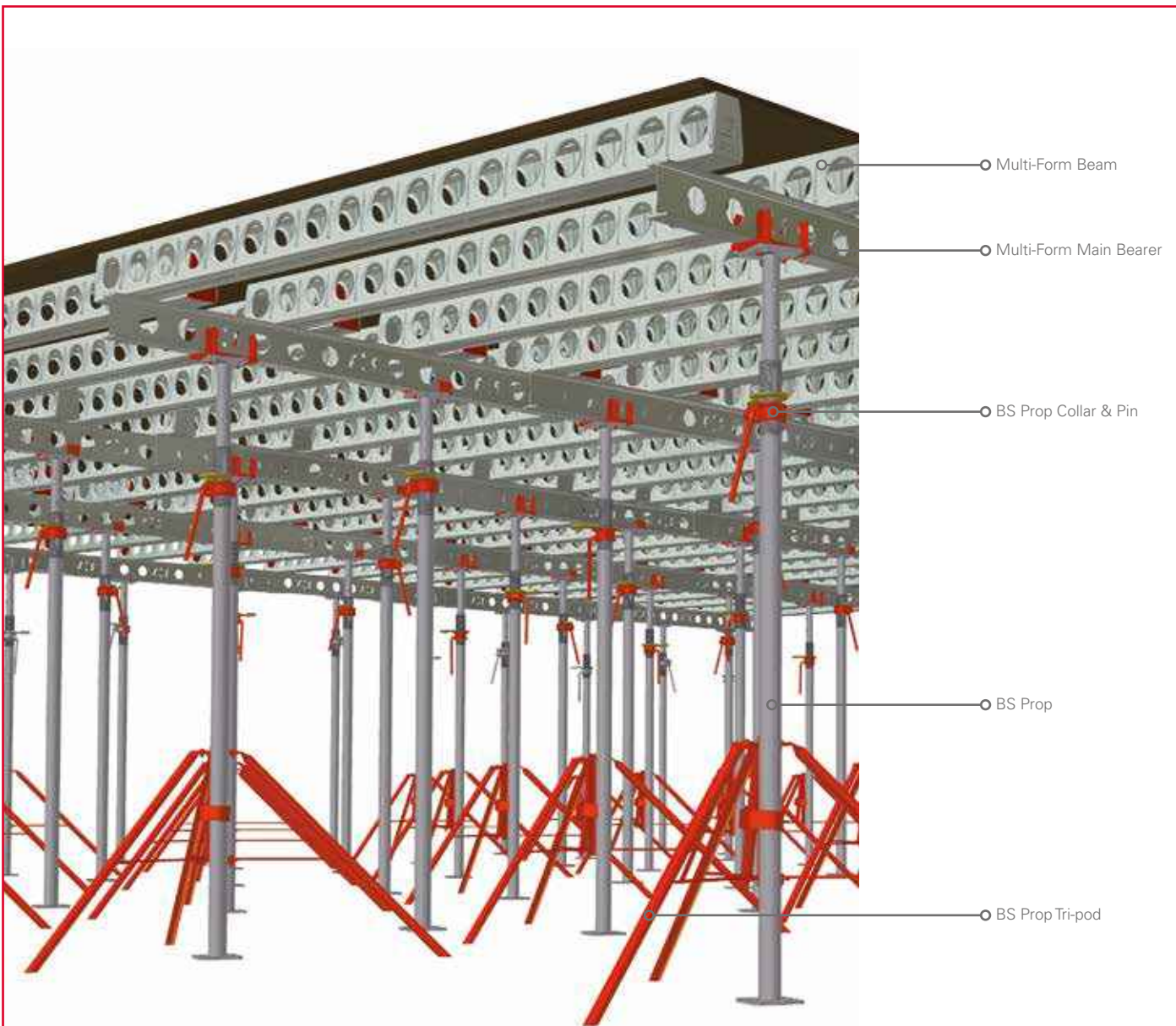

Trusses & Tri-Pods

BS Prop Tri-pods

BS Prop Tri-pods are used to keep the BS Props plumb during the erection phase.

CODE	DESCRIPTION	MASS(kg)
1130017	BS PROP TRI-POD	10.1



Alu-Up Prop Tri-pods

Alu-Up Prop Tri-pods are used to keep the Alu-Up Props plumb during the erection phase.

CODE	DESCRIPTION	MASS(kg)
5105201	ALU-UP PROP TRI-POD	15.7



Alu-Up Trusses

Alu-up Trusses are used to create towers and brace the Alu-Up Props in the vertical position.

CODE	DESCRIPTION	MASS(kg)
5105206	ALU-UP TRUSS 2500	32.3
5105207	ALU-UP TRUSS 1800	26.1
5105208	ALU-UP TRUSS 1600	24.4
5105209	ALU-UP TRUSS 1294	21.8
5105212	ALU-UP TRUSS 900	15.8





Application - Alu-Up Props

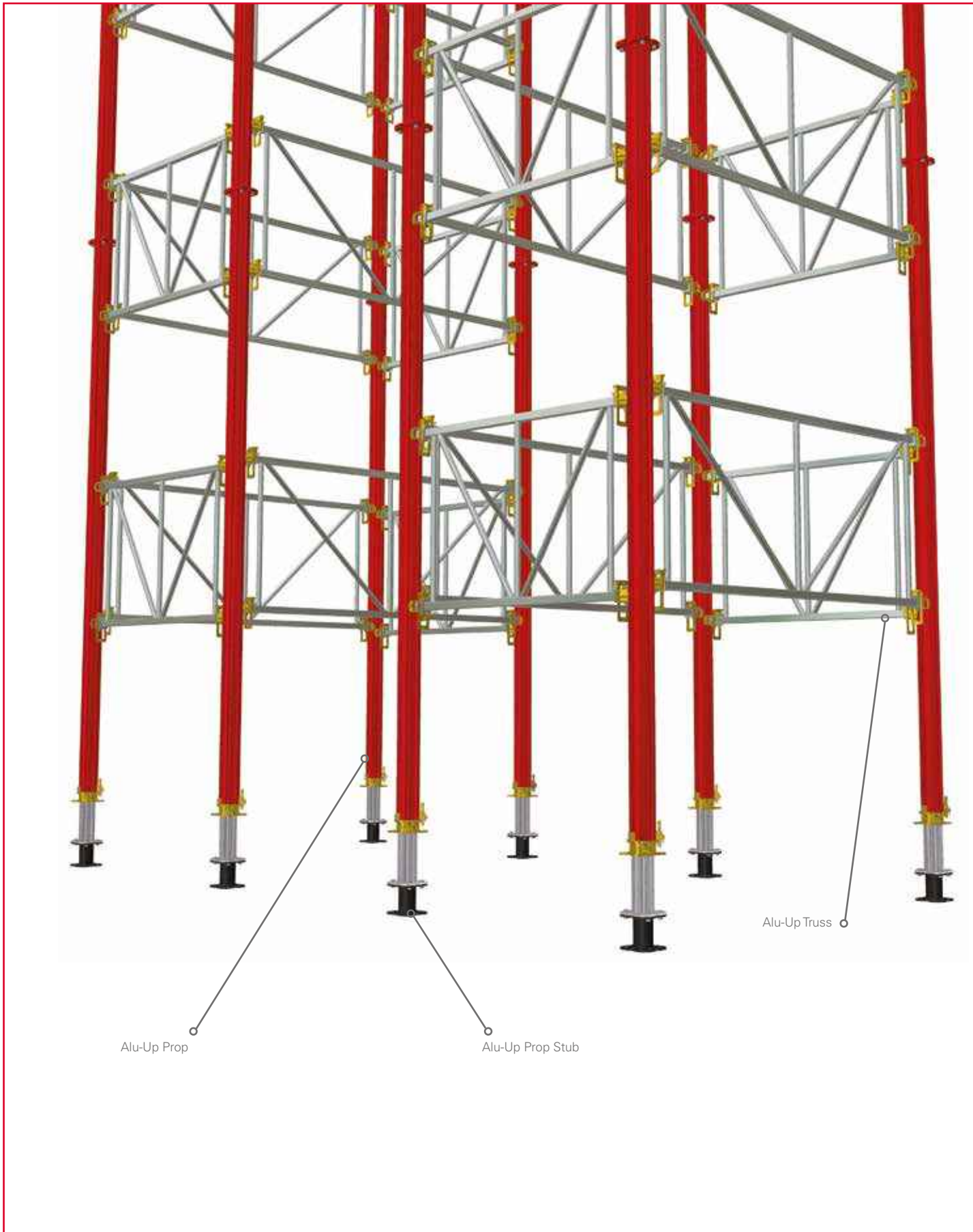

Supportwork - Kwik-Stage

Jacks and Base Plates

BT Jacks are inserted into the ends of Kwik-Stage Standards to provide the required vertical height adjustment and to secure the Multi-Form Prop Fork-Heads and /or Drop-Heads in position.

Kwik-Stage Base Plates are inserted into the bottom end of Kwik-Stage Standards to spread the load onto the bearing surface.

CODE	DESCRIPTION	MASS(kg)
0135302	KWIK-STAGE BT BASE PLATE	1.6
0140335	KWIK-STAGE 610 R/O BT BASE JACK	4.2



Kwik-Stage Standards

Kwik-Stage Standards make-up the vertical supports for bearers and formwork.

CODE	DESCRIPTION	MASS(kg)
1105005	KWIK-STAGE STANDARD 3000	15.5
1105004	KWIK-STAGE STANDARD 2500	12.9
1105003	KWIK-STAGE STANDARD 2000	10.3
1105002	KWIK-STAGE STANDARD 1500	7.7
1105001	KWIK-STAGE STANDARD 1000	5.2
1105000	KWIK-STAGE STANDARD 500	2.6
1105045	KWIK-STAGE STANDARD 250 C/W SOCKET	2.6



Kwik-Stage Ledgers

Kwik-Stage Ledgers are horizontal members used to keep the Kwik-Stage Standards in the vertical position.

CODE	DESCRIPTION	MASS(kg)
1105021	KWIK-STAGE LEDGER 2500	9.0
1105022	KWIK-STAGE LEDGER 2000	7.3
1105023	KWIK-STAGE LEDGER 1500	5.7
1105024	KWIK-STAGE LEDGER 1294	5.0
1105025	KWIK-STAGE LEDGER 1219	4.7
1105026	KWIK-STAGE LEDGER 1200	4.7
1105027	KWIK-STAGE LEDGER 1000	3.4
1105029	KWIK-STAGE LEDGER 900	3.1
1105031	KWIK-STAGE LEDGER 800	2.9
1105032	KWIK-STAGE LEDGER 600	2.4



Connectors

Kwik-Stage Connectors are used to locate Standards on top of each other.

CODE	DESCRIPTION	MASS(kg)
0145341	KWIK-STAGE CONNECTOR	0.4



Application - Multi-Form on Kwik-Stage

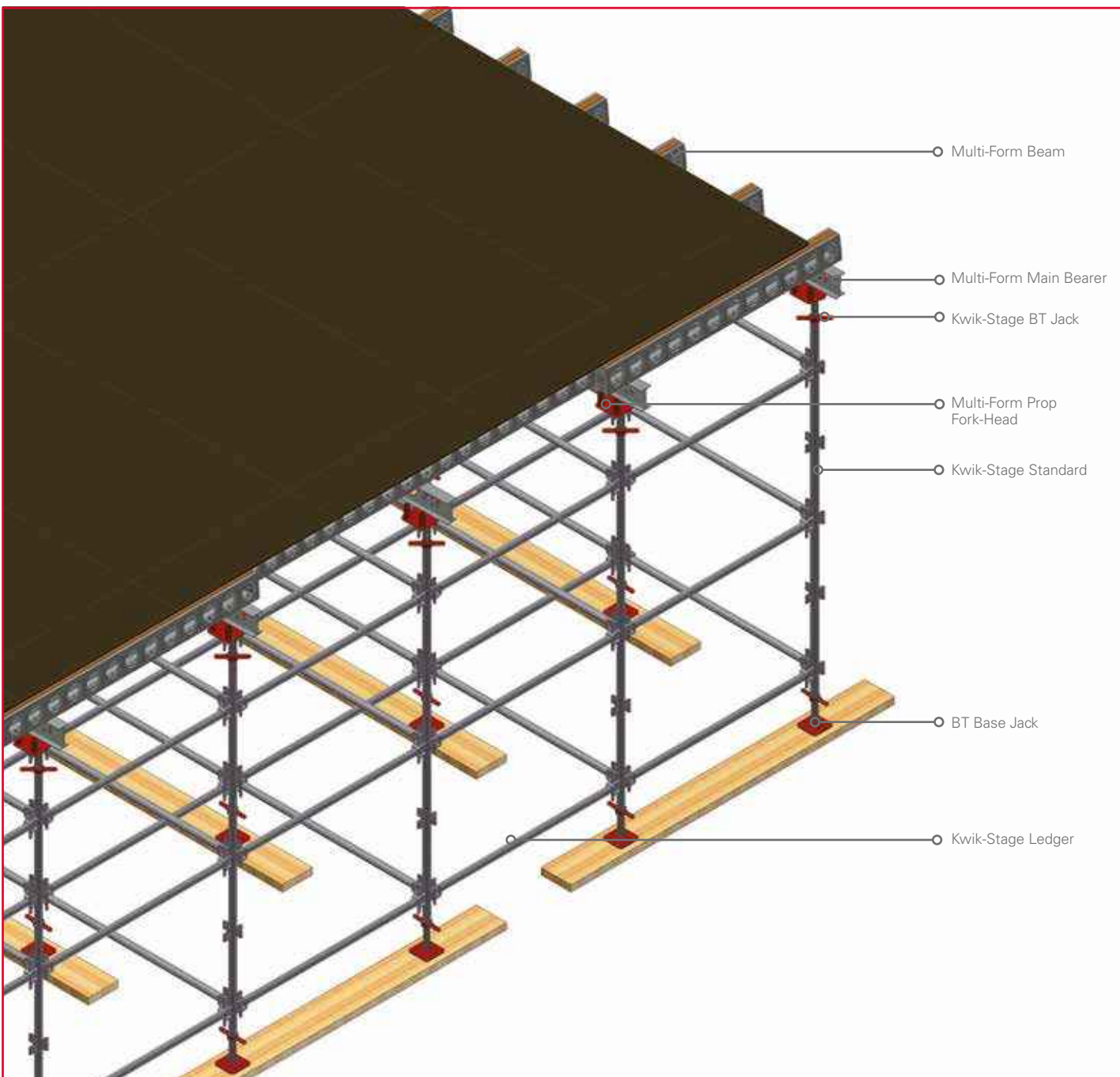

Beams & Bearers

Main Bearers

Main Bearers are used to support the secondary beams.

CODE	DESCRIPTION	MASS(kg)
1121013	MULTI-FORM MAIN BEARER 4500	44.0
1121012	MULTI-FORM MAIN BEARER 4200	41.0
1121011	MULTI-FORM MAIN BEARER 3900	38.1
1121010	MULTI-FORM MAIN BEARER 3600	35.2
1121009	MULTI-FORM MAIN BEARER 3300	32.3
1121008	MULTI-FORM MAIN BEARER 3000	29.3
1121007	MULTI-FORM MAIN BEARER 2700	26.4
1121006	MULTI-FORM MAIN BEARER 2400	23.5
1121005	MULTI-FORM MAIN BEARER 2100	20.6
1121004	MULTI-FORM MAIN BEARER 1800	17.6
1121003	MULTI-FORM MAIN BEARER 1500	14.7
1121002	MULTI-FORM MAIN BEARER 1200	11.8
1121001	MULTI-FORM MAIN BEARER 900	8.9



Multi-Form Beams

Multi-Form Beams are used as secondary beams, which support the plywood facing, to form the soffit of a concrete slab.

CODE	DESCRIPTION	MASS(kg)
1120008	MULTI-FORM BEAM 3900	29.3
1120014	MULTI-FORM BEAM 3600	27.2
1120013	MULTI-FORM BEAM 3300	24.9
1120006	MULTI-FORM BEAM 3000	22.7
1120015	MULTI-FORM BEAM 2700	20.4
1120005	MULTI-FORM BEAM 2400	18.3
1120004	MULTI-FORM BEAM 2100	16.1
1120003	MULTI-FORM BEAM 1800	13.8
1120002	MULTI-FORM BEAM 1500	11.6
1120016	MULTI-FORM BEAM 1200	9.5
1120001	MULTI-FORM BEAM 900	7.2
1605049	MULTI-FORM BEAM LIFTING FORK	2.6



Plywood

21mm Plywood placed on top of the Multi-Form main - and secondary beams provides the facing or soffit onto which the new concrete slab is poured. Plywood is available in many different types, thicknesses, sizes and qualities and it is up to the contractor to decide which type to use.

CODE	DESCRIPTION	MASS(kg)
5120163	FORM-BIRCH PLYWOOD 2400 X 600 X 21MM	20.5
5120091	FORM-COMBI PLYWOOD 2500 X 625 X 21MM	25.0
5120056	FORM-ECO PLYWOOD 2400 X 600 X 21MM	22.3
5120055	FORM-ECO PLYWOOD 2500 X 1250 X 21MM	44.5

* Other types, sizes and thicknesses are also available.



Prop Fork-Heads

Multi-Form Prop Fork-Heads are used to keep the Multi-Form Main Bearers centrally positioned over the BS Props.

CODE	DESCRIPTION	MASS(kg)
1130016	MULTI-FORM PROP FORK-HEAD	1.8

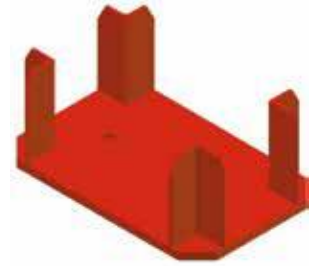

Application - Fork-Heads



Drop-Heads

The Multi-Form Drop-Heads are used to Kwik-Strip the Multi-Form system. The Props remain in position while the bearers and plywood are recovered for re-use. The Multi-Form Drop Heads support the Multi-Form Main Bearers, Multi-Form Beams and plywood decking.

CODE	DESCRIPTION	MASS(kg)
1605026	MULTI-FORM DROP-HEAD	75



Application - Drop-Heads - Unstripped Position

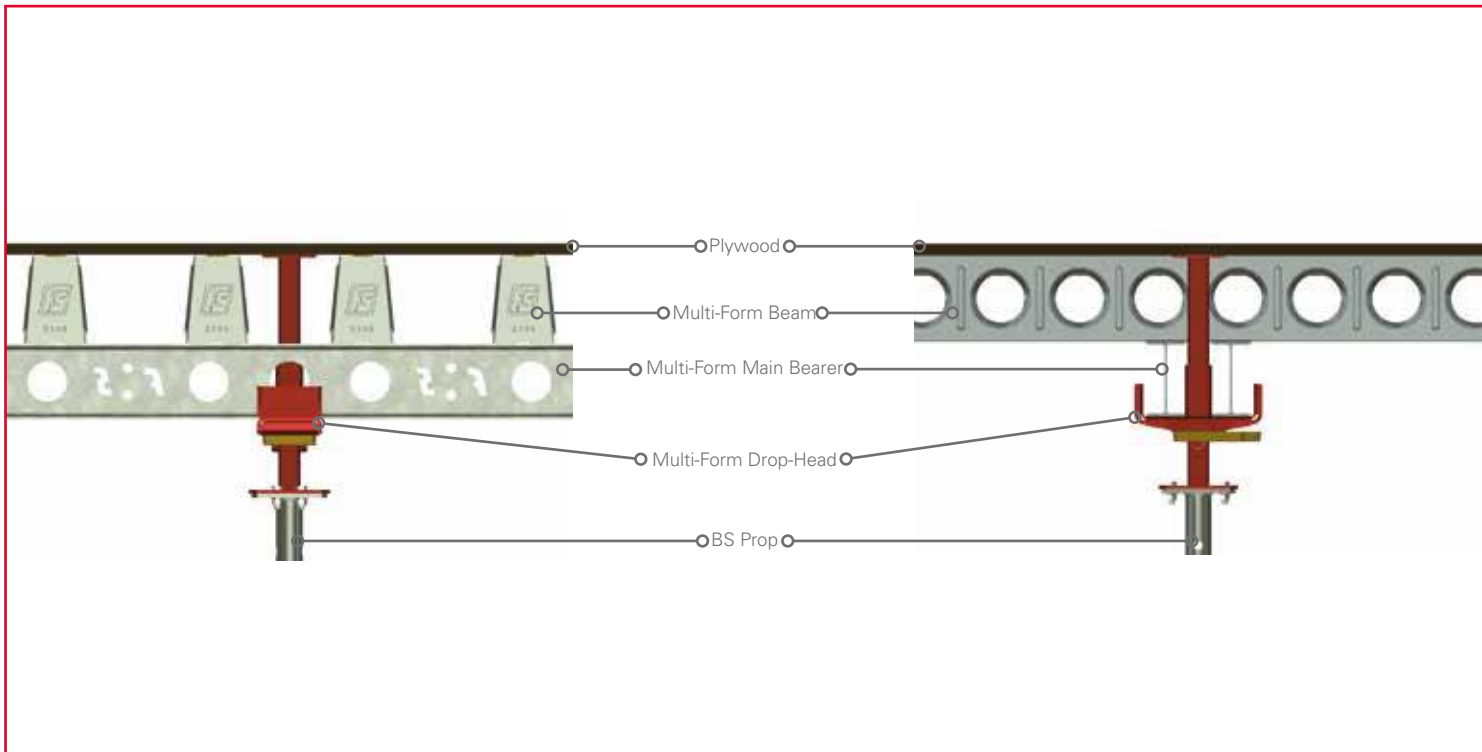

Application - Drop-Heads - Stripped Position





multi-form

Application - Multi-Form on Kwik-Stage

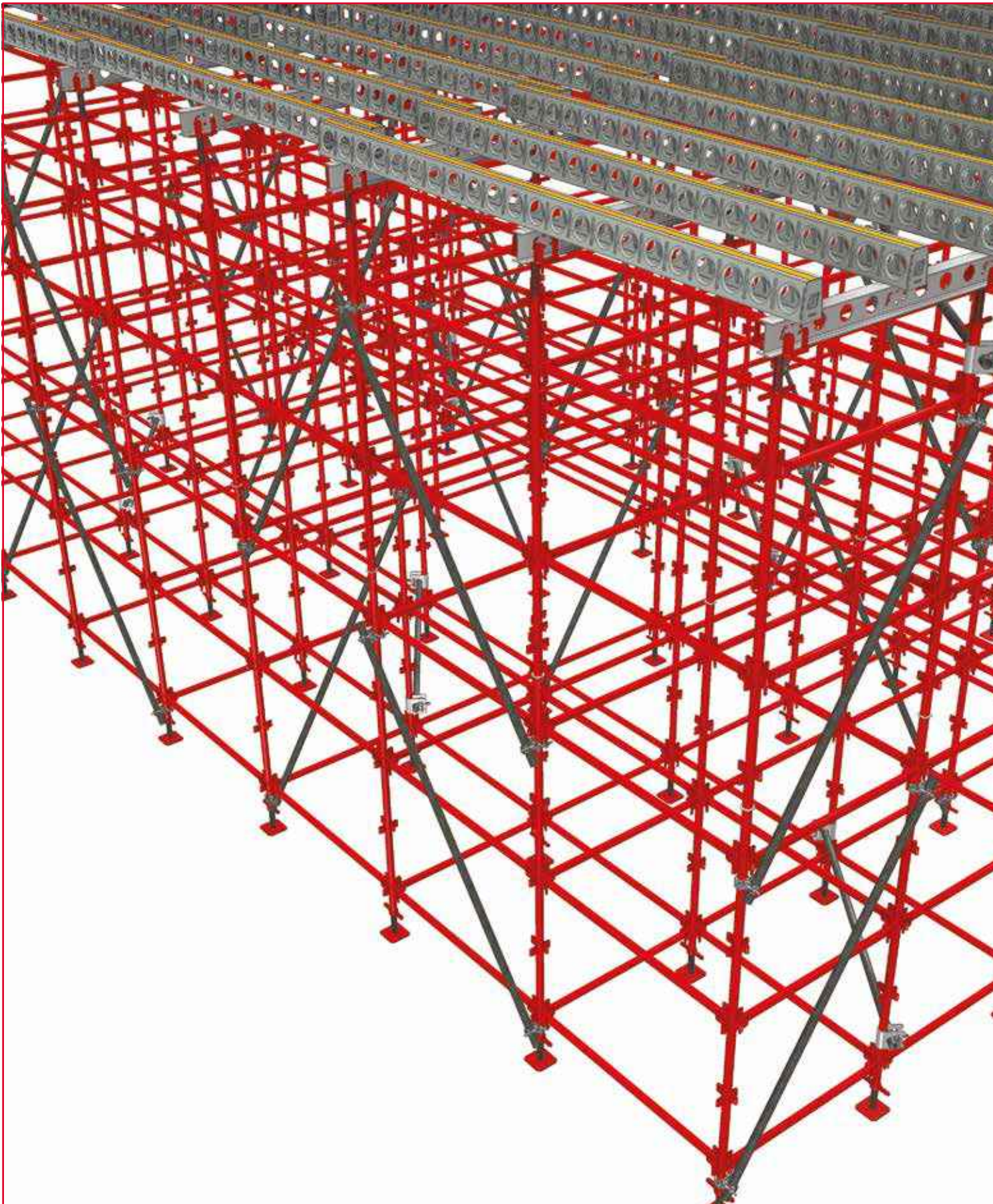

Guardrails

Multi-Form Guardrail Bracket

Multi-Form Guardrail Brackets are used as stanchions, to secure safety handrails in position around the edges of the Multi-Form systems. They may also be clamped onto an existing concrete slab of up to 900mm thick.

CODE	DESCRIPTION	MASS(kg)
1130238	MULTI-FORM GUARDRAIL BRACKET	14.6



Application - Multi-Form Guardrails

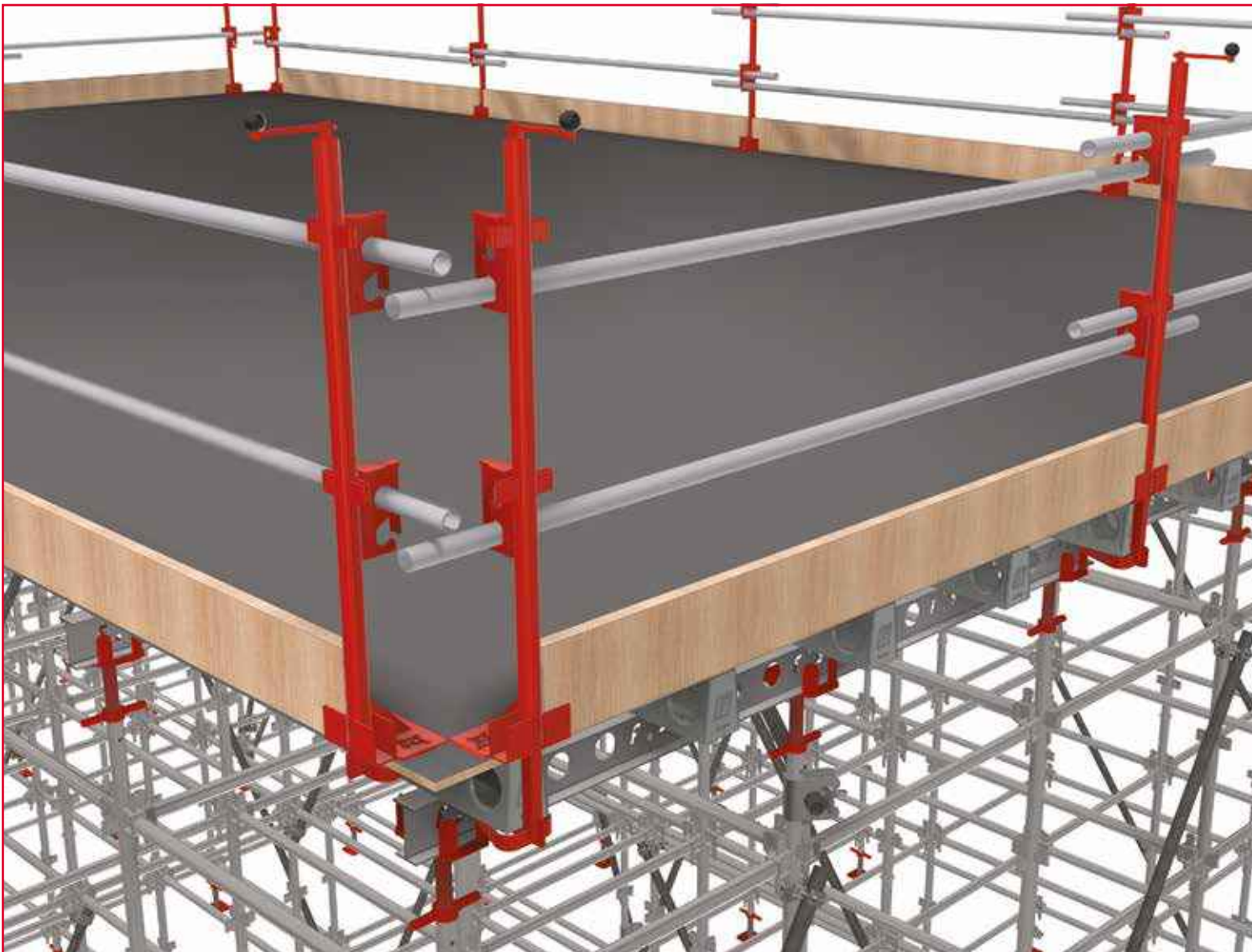

Table Heads & Connections

Multi-Form Table Heads are fixed to the ends of the Props with the aid of a wedge. This is to keep the Multi-Form Main Bearers in position when the system is used for Tables.

CODE	DESCRIPTION	MASS(kg)
1605028	MULTI-FORM TABLE HEAD	10.6
1605006	MULTI-FORM FLANGE CLIP	0.1
1605007	MULTI-FORM WALER CHANNEL	0.4
1605008	MULTI-FORM CUP SQUARE BOLT	0.1
1605036	MULTI-FORM LINDAPTOR	0.1
1605035	MULTI-FORM M14 X 65 BOLT	0.1
1605200	MULTI-FORM KWIK-FIX BOLT	0.2
1605201	MULTI-FORM KWIK-FIX NUT	0.2



Table Lifting Brackets

Multi-Form Table Lifting Brackets are used to move assembled Multi-Form Tables in the absence of a Multi-Form Table C-Hook and when loading or unloading vehicles.

CODE	DESCRIPTION	MASS(kg)
1605041	MULTI-FORM TABLE LIFTING BRACKET	13.7

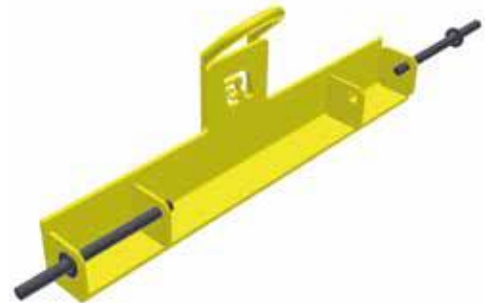

Table C-Hook

The Multi-Form Table C-Hooks are used to lift or move assembled Multi-Form Tables.

CODE	DESCRIPTION	MASS(kg)
1605029	MULTI-FORM TABLE C-HOOK	558.3
1605051	MULTI-FORM TABLE C-HOOK SAFETY SLING	5.0



Table Trolley

A pair of Multi-Form Table Trolleys joined together by the Multi-Form Table Trolley Spacer and Brace are used to move assembled Multi-Form Tables around on existing concrete slabs.

CODE	DESCRIPTION	MASS(kg)
1605050	MULTI-FORM TABLE TROLLEY	102.0
1605095	MULTI-FORM TABLE TROLLEY SPACER	6.5
1605096	MULTI-FORM TABLE TROLLEY BRACE	8.3



Application - Tables

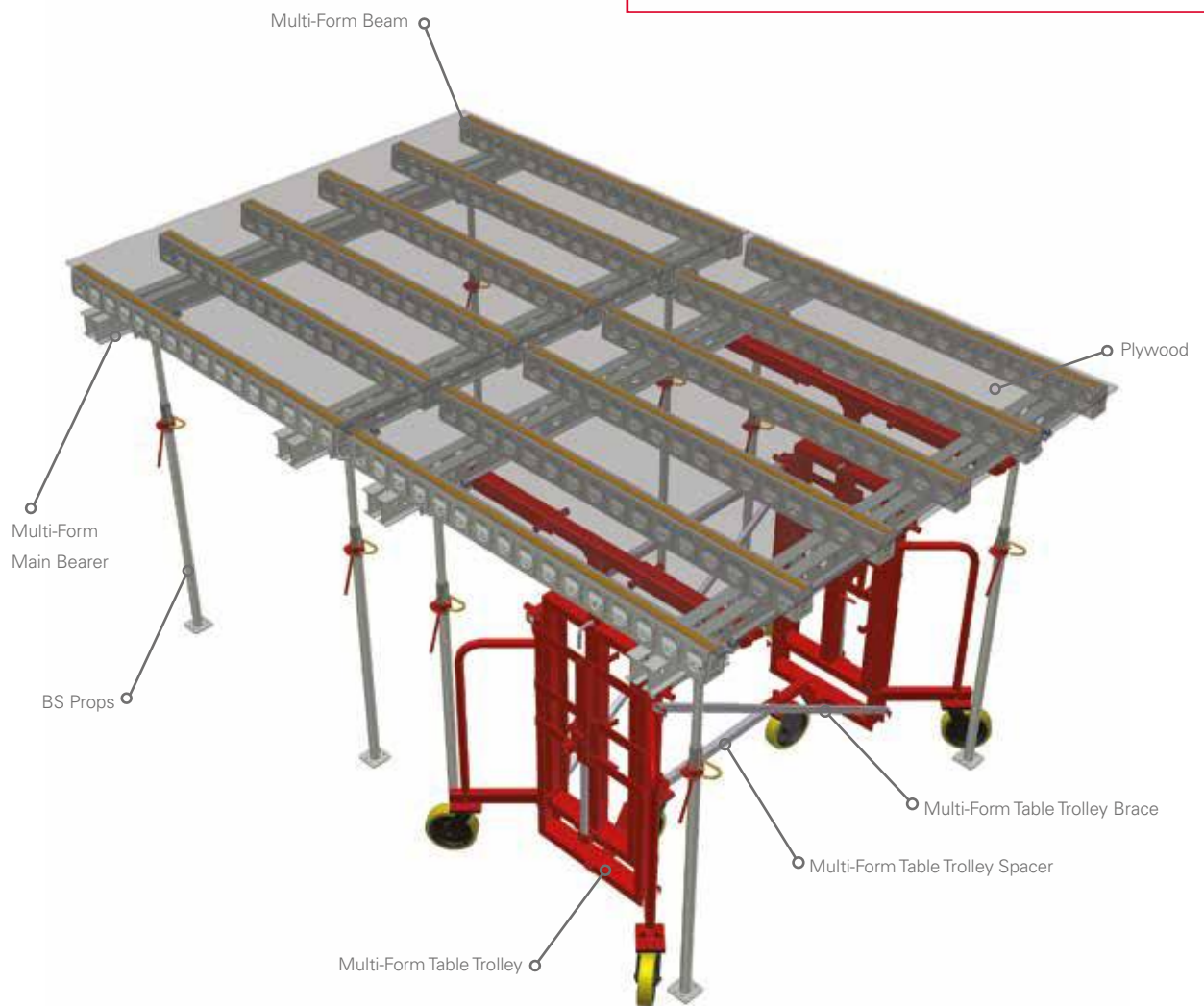
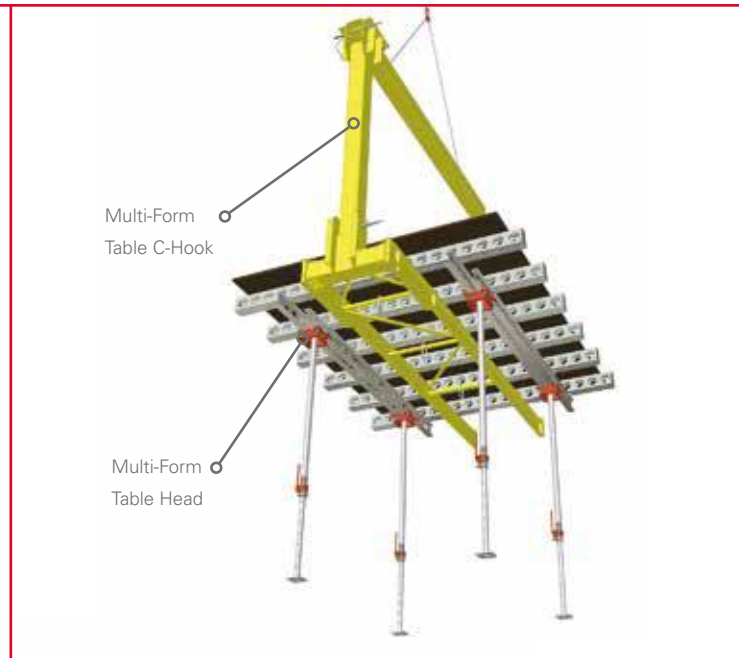

International Branches

Ghana - Accra

Plot 29, Off Spintex Road, Tema
Motorway Industrial Area,
Accra, Ghana
Tel +233 30397 3722 /
+233 20868 1651

Kenya - Nairobi

Plot 15081/5/27 Old Airport North
Road, Nairobi, Kenya
Tel +254 724 004 781 /
+254 718 220 412

Mauritius - Port Louis

Anse Courtois Street, Montebello,
Pailles, Mauritius
Tel +230 286 6175 /
+230 5940 2551

Mozambique - Palma

N'Cumbi Road No. R762,
Palma, Mozambique
Tel +258 86 109 6443 /
+258 84 774 3788

Mozambique - Pemba

Estrada Nacional EN106, Muxara,
Pemba, Cabo Delgado, Mozambique
Tel: +258 84 312 4146

Namibia - Swakopmund

608 Nelson Mandela Avenue,
Swakopmund, Namibia
Tel +264 64 46 3677 /
+264 64 46 2720

Namibia - Windhoek

Cnr Nickle & Michelle McClean Street,
Prosperita, Windhoek, Namibia
Tel +264 61 425 350 /
+264 081 164 9806

Swaziland - Matsapha

Lot 814, King Mswati III Ave,
Matsapha, Swaziland
Tel +268 25 18 8360 /
+268 7668 5337

Tanzania - Dar es Salaam

Cnr Mwaikibaki Road & Kilimani
Close, Plot 1034/5 Mbezi Kawe,
Dar es Salaam, Tanzania
Tel +255 75 638 8115 /
+255 74 299 8022

Zambia - Kitwe

Plot 16, Karibu Business Park,
Kitwe, Zambia
Tel +260 966 880009 /
+ 260966 923 854

Zambia - Lusaka

Plot 397 A/3/B Kufue Road,
Lusaka, Zambia
Tel +260 968 491061 /
+ 260966 923 854

South African Branches

Ballito

Labora Terra Industrial Park,
Shakas Rock Road, Umhlali,
Ballito, KwaZulu Natal
Tel +27 (0) 32 947 9430

Bloemfontein

26 Tibbie Visser Street, Estoire
Small Holdings District,
Bloemfontein, Free State
Tel +27 (0) 51 432 5555

Cape Town

8 Rondevallei Road, Hagley,
Kuilsrivier, Western Cape
Tel +27 (0) 21 528 6500

Durban South

16 Stroude Place, Isipingo,
KwaZulu Natal
Tel +27 (0) 31 902 2677

East London

5 Ray Craib Crescent,
Beacon Bay, Eastern Cape
Tel +27 (0) 43 748 2558

Gauteng

Poplar Crescent, Lords View
Industrial Park, Klipfontein,
Chloorkop X66, Gauteng
Tel +27 (0) 10 601 6313

George

10 Ring Road, George Industrial,
George, Western Cape
Tel +27 (0) 44 695 0294

Kathu

33 Kalk Street, Industrial Area,
Kathu, Northern Cape
Tel +27 (0) 53 723 2194

Lephalale

Rietspruit Plot 23, Portion 46,
Witkop Road, Lephalale, Limpopo
Tel +27 (0) 14 763 7982

Margate

Industrial Road, Margate,
KwaZulu Natal
Tel +27 (0) 39 317 1708

Nelspruit

Erf 379, Rocky Drift,
Mpumalanga
Tel +27 (0) 13 758 1036

Newcastle

6 Schonland Street, Riverside
Industrial Area, Newcastle,
KwaZulu Natal
Tel +27 (0) 34 375 7697

Pietermaritzburg

Market Road Ext, Mkondeni,
Pietermaritzburg, KwaZulu Natal
Tel +27 (0) 33 346 1767

Polokwane

62 Goud Street, Laboria,
Polokwane, Limpopo
Tel +27 (0) 15 293 0450

Port Elizabeth

4 Kendle Street, Neave Industrial
Area, Eastern Cape
Tel +27 (0) 41 453 2317

Richards Bay

111 Alluminia Alley, Alton Industrial
North, KwaZulu Natal
Tel +27 (0) 35 751 1140

Rustenburg

3 Ferro Street, Rustenburg,
North West Province
Tel +27 (0) 14 538 2540

Vereeniging

Cnr Telford & Van Riebeeck Street,
Duncanville, Gauteng
Tel +27 (0) 16 455 1611

Witbank

TP66 Geodesic Crescent, Marelden
Ext 3, Techno Park, Witbank,
Mpumalanga
Tel +27 (0) 13 690 2833

Head Office

181 Barbara Road,
Elandsfontein, Gauteng
PO Box 669, Isando, 1660
Tel +27 (0) 11 842 4000

 **multi-form**

Waco Africa / Head Office: PO Box 669, Isando, 1600.
181 Barbara Road, Elandsfontein. Tel: 011 842 4000

 **form-scaff**

Technical Advice Centre 0800 20 50 29 / 011 842 4011
www.formscaff.com