

Product Catalogue
Horizontal Formwork

FS kwik-strip

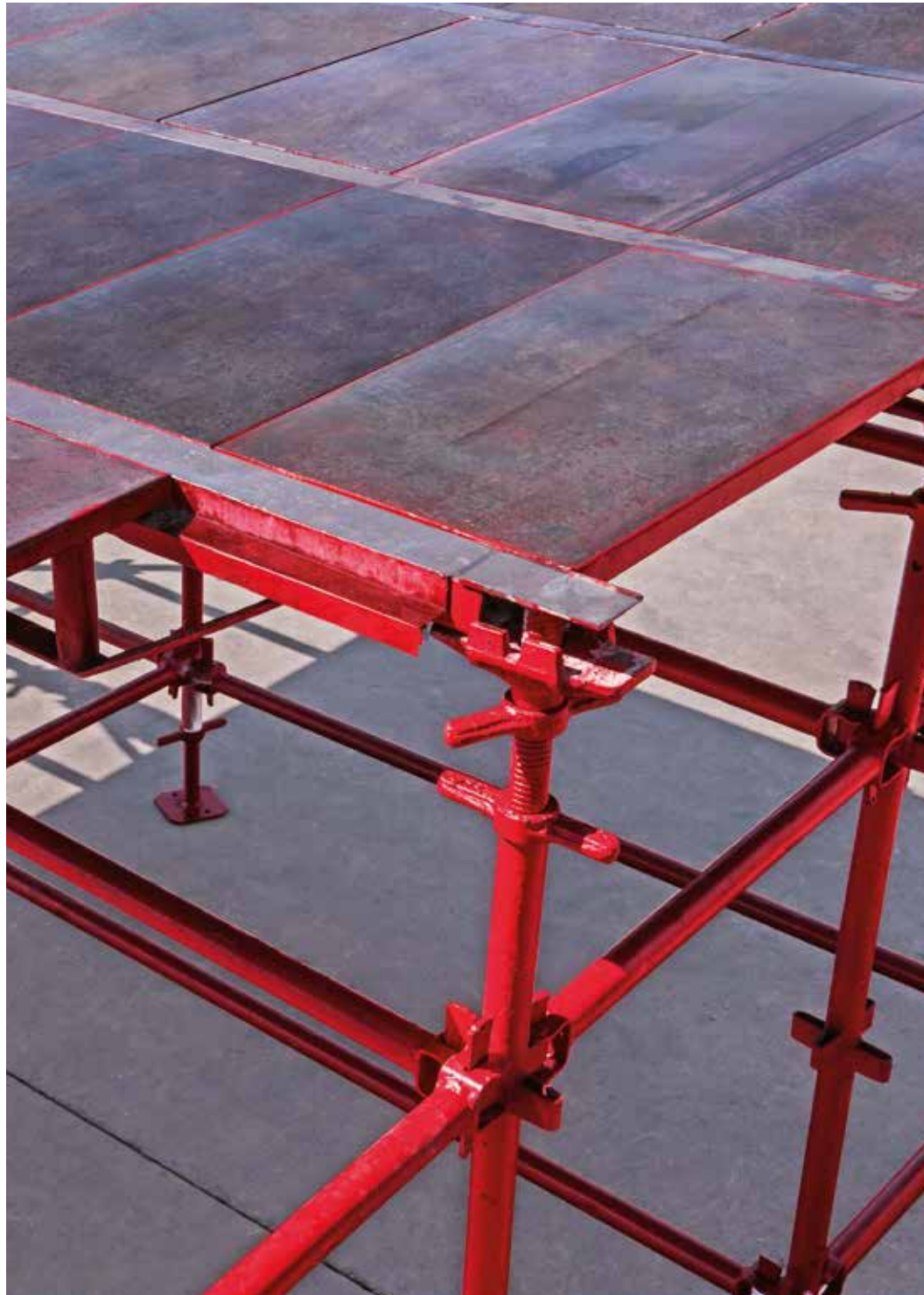

FS form-scaff

Formwork & Scaffolding
Solutions

We are
WACO



Form-Scaff is South Africa's leading supplier of formwork, falsework and scaffolding to the construction and civil engineering industries. Form-Scaff not only manufactures, hires and sells world-class products, but also provides the design skills, technical advice and support that comes with having 50 years experience and more than 30 branches locally and internationally.

We are Waco International

Form-Scaff is part of Waco International, a focused equipment rental and industrial services business with operations in Africa (South Africa and other sub-Saharan African countries), Australasia (Australia and New Zealand) and the United Kingdom.

The Group provides services in the areas of formwork, shoring and scaffolding, insulation, painting and blasting, hydraulics and suspended access platforms, relocatable modular buildings, portable sanitation products and integrated hygiene services.

Disclaimer:

Copyright in this catalogue vests in Form-Scaff, a division of Waco Africa (Proprietary) Limited ("Form-Scaff") and extends inter alia, to the making of copies in whole or in part without the prior written consent of Form-Scaff.

While every effort has been made to ensure the accuracy of the information in this catalogue, we cannot accept responsibility for any errors which may occur as a result of reliance on the contents of this catalogue and are not liable for any loss of any nature that may be incurred as a result of such reliance. Details of any of the products may change without prior notice.

The customer must ensure that 'good practice' is adopted on site by competent persons and that the products shown in this catalogue are erected, used and stripped in accordance with the relevant Codes of Practice and the OHS Act and Regulations 85 of 1993. This catalogue does not contain any design detail but lists and depicts the items available under this product range. The responsibility for design is the responsibility of the customer.

Note: The colours used in this document are for illustrative purposes only and may differ on actual products

Contents



kwik-strip

- Page 2** Kwik-Strip Overview
- Page 3** General Assembly
- Page 4** Supportwork - Kwik-Stage
- Page 5** Ledgers
- Page 6** Top Jacks
- Page 7** Beams
- Page 9** Panels
- Page 11** Handrails and Bracing
- Page 12** Braces

Contact Details

- Page 13** Head Office & Branches

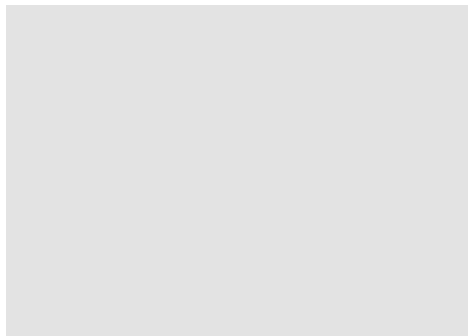
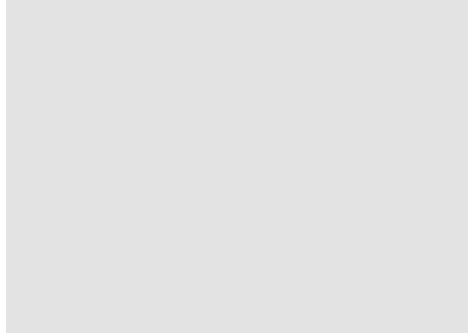



kwik-strip



Kwik-Strip Decking

The same high quality products used in the access section are also used extensively for support work to various decking systems.

Form-Scaff's highly successful Kwik-Strip Decking range consists of Double Headed Jacks, Kwik-Strip Beams and Deck Panels. These are best supported on the safe and versatile Kwik-Stage system.

Various grids are available for different slab thicknesses, load applications and product optimisation. Form-Scaff's fibreglass Coffers and Troughs are also supported on Kwik-Stage.

System Features

- Kwik-Strip facility.
- Various height configurations.
- Horizontal ledgers provide support for easy access to decking.
- Versatile and safe.



General Assembly

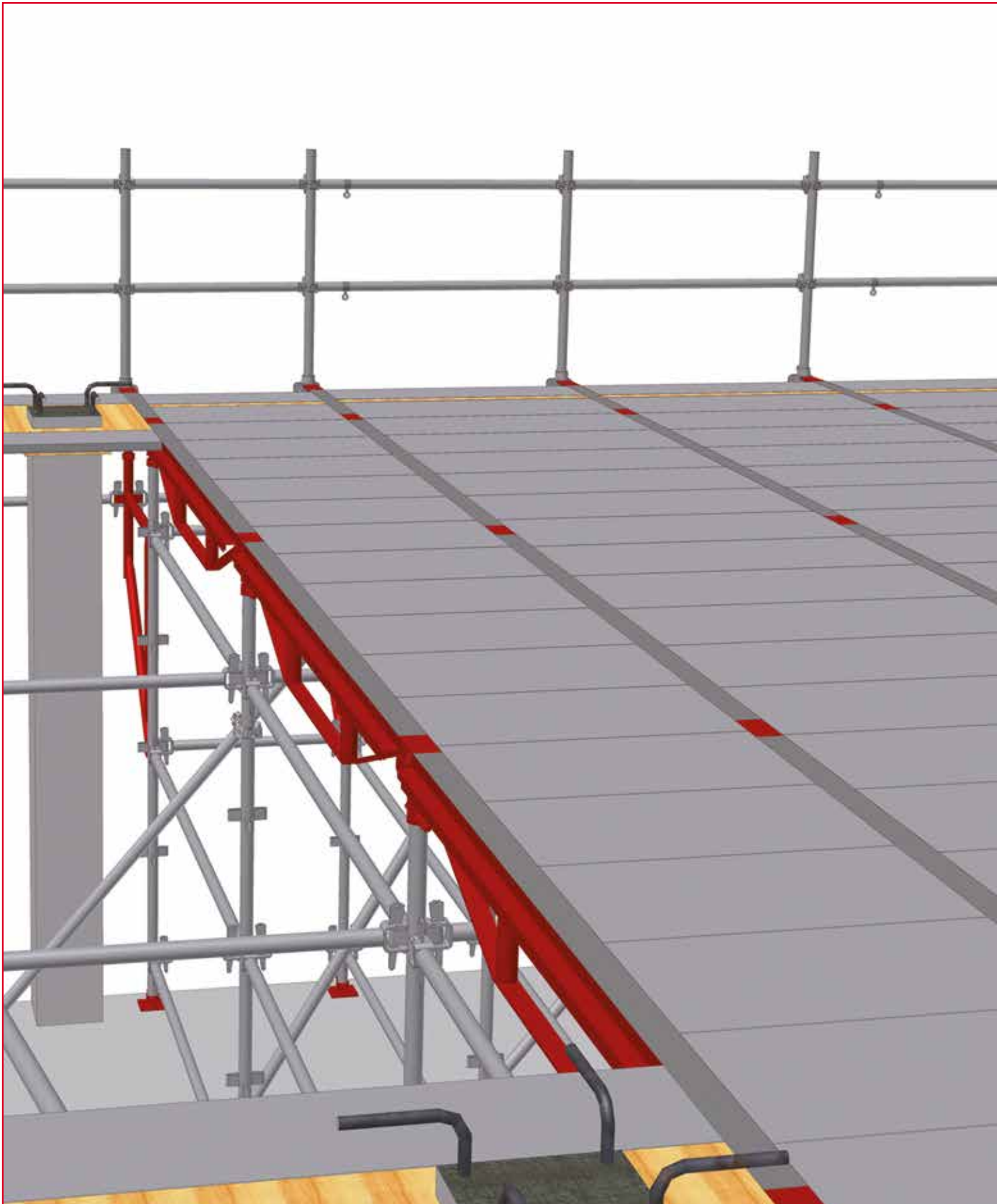

Supportwork - Kwik-Stage

Jacks and Base Plates

Kwik-Stage Base Jacks are inserted into the ends of Kwik-Stage Standards to provide the required vertical height adjustment.

Kwik-Stage Base Plates are inserted into the bottom end of Kwik-Stage Standards to spread the load onto the bearing surface.

CODE	DESCRIPTION	MASS(kg)
0135302	KWIK-STAGE BT BASE PLATE	1.6
0140335	KWIK-STAGE 610 R/O BT BASE JACK	4.2



Kwik-Stage Standards

Kwik-Stage Standards make-up the vertical supports for bearers, formwork and access.

CODE	DESCRIPTION	MASS(kg)
1105005	KWIK-STAGE STANDARD 3000	15.5
1105004	KWIK-STAGE STANDARD 2500	12.9
1105003	KWIK-STAGE STANDARD 2000	10.3
1105002	KWIK-STAGE STANDARD 1500	7.7
1105001	KWIK-STAGE STANDARD 1000	5.2
1105000	KWIK-STAGE STANDARD 500	2.6
1105045	KWIK-STAGE STANDARD 250 C/W SOCKET	2.6



Connectors

Kwik-Stage Connectors are used to locate Standards on top of each other.

CODE	DESCRIPTION	MASS(kg)
0145341	KWIK-STAGE CONNECTOR	0.4



Kwik-Stage Ledgers

Kwik-Stage Ledgers are horizontal members used to keep the Kwik-Stage Standards in the vertical position.

CODE	DESCRIPTION	MASS(kg)
1105021	KWIK-STAGE LEDGER 2500	9.0
1105022	KWIK-STAGE LEDGER 2000	7.3
1105023	KWIK-STAGE LEDGER 1500	5.7
1105024	KWIK-STAGE LEDGER 1294	5.0
1105025	KWIK-STAGE LEDGER 1219	4.7
1105026	KWIK-STAGE LEDGER 1200	4.7
1105027	KWIK-STAGE LEDGER 1000	3.4
1105094	KWIK-STAGE LEDGER 990	3.4
1105029	KWIK-STAGE LEDGER 900	3.1
1105031	KWIK-STAGE LEDGER 800	2.9
1105032	KWIK-STAGE LEDGER 600	2.4



Bridging Ledgers

Kwik-Stage Bridging Ledgers are used to bridge between two Standards, reducing the number of Standards required.

CODE	DESCRIPTION	MASS(kg)
1105106	KWIK-STAGE BRIDGING LEDGER 1800	21.3



Application - Kwik-Stage Support

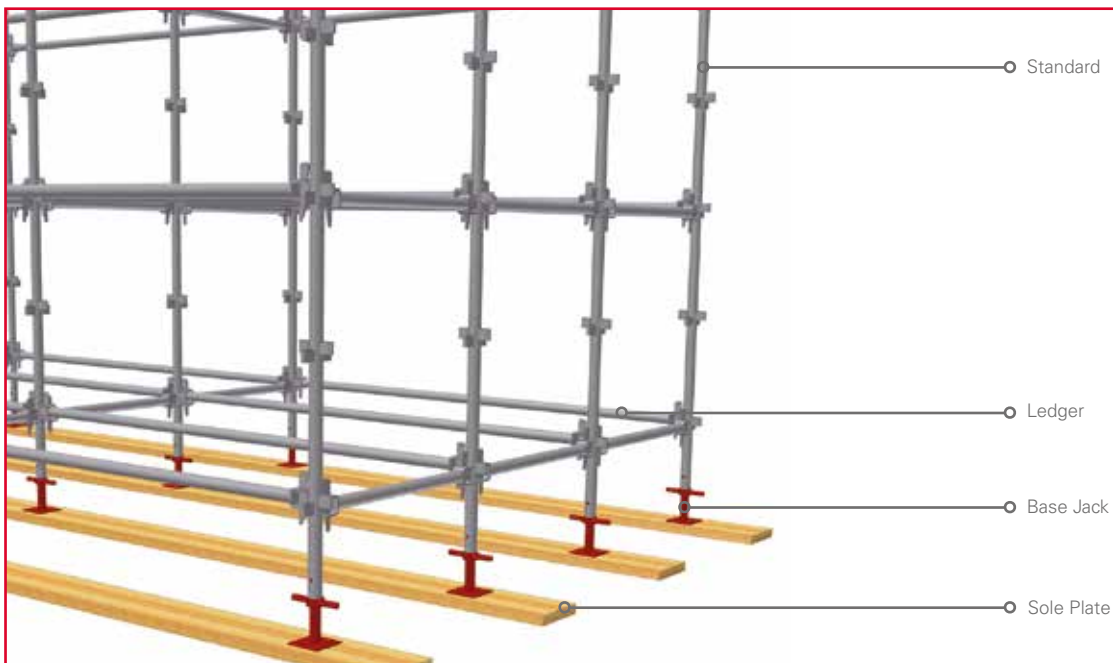

Top Jacks

Double Headed Jacks

Double Headed Jacks are inserted into the top end of Kwik-Stage Standards to secure the Kwik-Strip Beam in position.

CODE	DESCRIPTION	MASS(kg)
1130223	KWIK-STRIP 610 D/H JACK NON-TILT	7.9



Three Way Double Headed Jacks

Three Way Double Headed Jacks facilitate the direction change of Kwik-Strip Beams.

CODE	DESCRIPTION	MASS(kg)
1130212	KWIK-STRIP 3 WAY 610 D/H JACK	8.5



Application - Double Headed Jacks

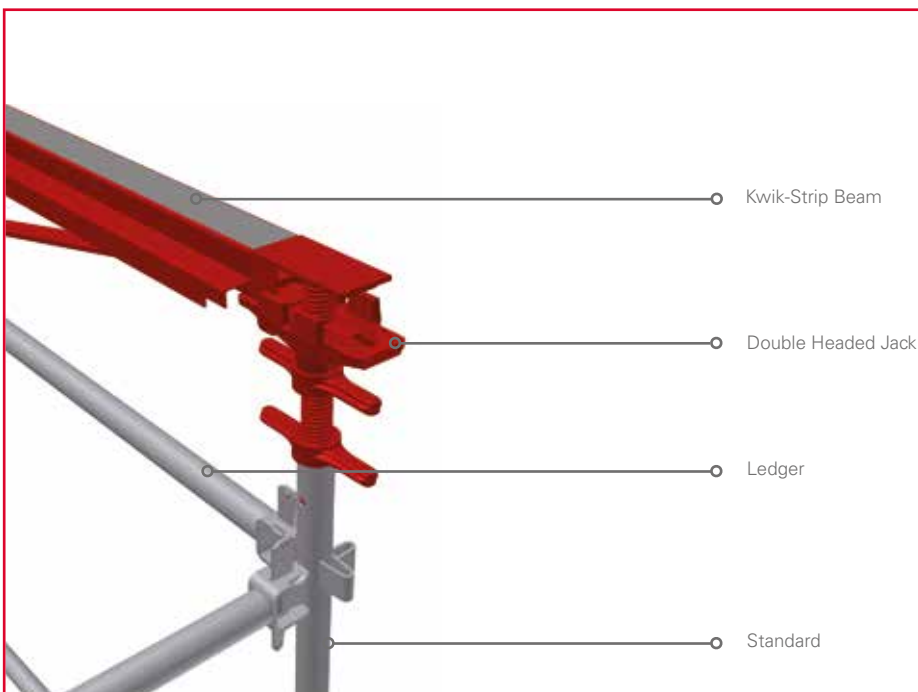

Kwik-Strip Beams

Kwik-Strip Beams support Deck Panels on either side of the beam. They are supported by Double Headed Jacks.

CODE	DESCRIPTION	MASS(kg)
1125183	KWIK-STRIP 2500 COINED BEAM	30.9
1125184	KWIK-STRIP 2000 COINED BEAM	25.5
1125185	KWIK-STRIP 1500 COINED BEAM	17.3
1125186	KWIK-STRIP 1219 COINED BEAM	11.9
1125187	KWIK-STRIP 1000 COINED BEAM	9.6
1125188	KWIK-STRIP 900 COINED BEAM	8.5



Folded Sections

Folded Sections facilitate 'make-up' sections between the last Kwik-Strip Beam and the slab edge against a wall or concrete beam.

CODE	DESCRIPTION	MASS(kg)
8015121	KWIK-STRIP FOLDED SECTION 1200	4.4
8015128	KWIK-STRIP FOLDED SECTION 900	3.3
8015122	KWIK-STRIP FOLDED SECTION 600	2.2



Application - Folded Sections



Application - Kwik-Strip Beams



Deck Panels

Deck Panels are used to form concrete slabs and are supported by Kwik-Strip Beams.

CODE	DESCRIPTION	MASS(kg)
1125195	DECKING PANEL 1425 X 450 (Double Stiffener)	26.2
1125194	DECKING PANEL 1425 X 450 (Single Stiffener)	21.9
1125196	DECKING PANEL 1425 X 300	11.8
4015201	DECKING PANEL 1219 X 457	19.1
4015202	DECKING PANEL 1219 X 381	17.0
4015203	DECKING PANEL 1219 X 305	11.2
4015204	DECKING PANEL 1219 X 229	9.0
4015205	DECKING PANEL 1219 X 152	6.7
1145301	DECKING PANEL 825 X 450	13.2
1145302	DECKING PANEL 825 X 300	7.7
1145303	DECKING PANEL 825 X 150	4.6
1145304	DECKING PANEL 825 X 100	3.6
4015214	DECKING PANEL 610 X 305	6.1
4015216	DECKING PANEL 610 X 229	4.9
4015215	DECKING PANEL 610 X 152	3.7

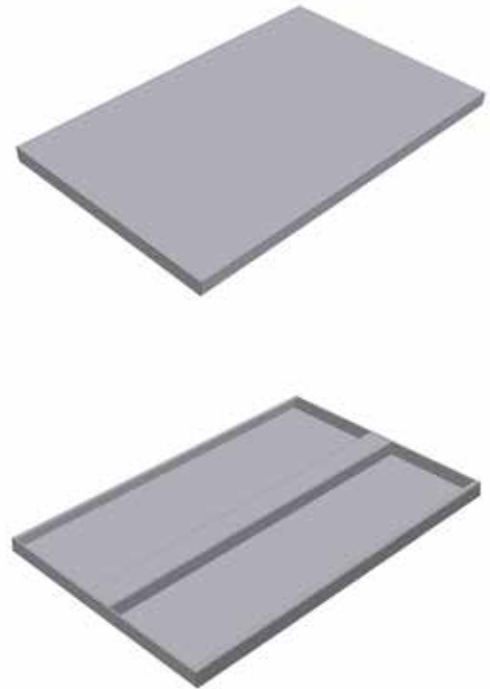

Deck Fillers

Deck Fillers facilitate 'make-up' sections by sliding over the adjacent Deck Panels.

CODE	DESCRIPTION	MASS(kg)
1140253	825 X 250 DECK FILLER	3.9
4025001	1219 X 203 DECK FILLER	4.9
1125197	1425 X 200 DECK FILLER	5.7



Cantilever Brackets

Kwik-Stage Cantilever Brackets are used to cantilever out from the existing lower floor slab to facilitate the top slab edge and working platform.

CODE	DESCRIPTION	MASS(kg)
1130204	KWIK-STAGE CANT BRACKET 900	12.7
1130205	KWIK-STAGE CANT BRACKET 532	7.9



Application - Cantilevers

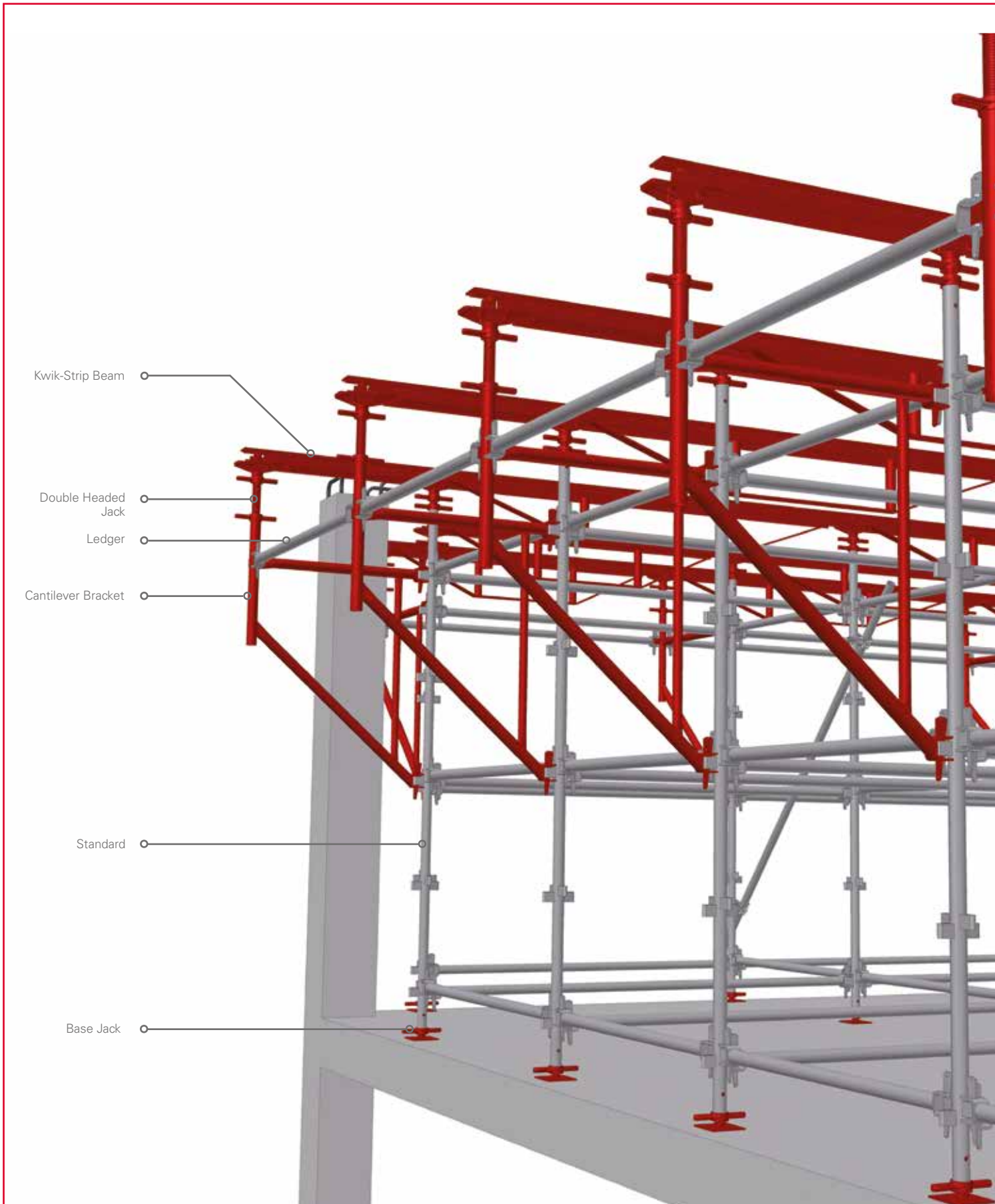

Kwik-Strip End Brackets

The Kwik-Strip End Brackets attach to the Double Headed Jacks around the perimeter of the slab, facilitating handrail uprights.

CODE	DESCRIPTION	MASS(kg)
1130232	KWIK-STRIP END BRACKET	2.9



Scaffold Tubes

Scaffold Tubes are used for a variety of applications in support work and access scaffolding, i.e. bracing, lacing, handrails etc.

CODE	DESCRIPTION	MASS(kg)
1905151	SCAFFOLD TUBE 6100	22.7
1905098	SCAFFOLD TUBE 5500	20.5
1905097	SCAFFOLD TUBE 5000	18.6
1905096	SCAFFOLD TUBE 4500	16.7
1905095	SCAFFOLD TUBE 4000	14.9
1905094	SCAFFOLD TUBE 3500	13.0
1905093	SCAFFOLD TUBE 3000	11.2
1905092	SCAFFOLD TUBE 2500	9.3
1905091	SCAFFOLD TUBE 2000	7.4
1905090	SCAFFOLD TUBE 1500	5.6
1905089	SCAFFOLD TUBE 1000	3.7
1905088	SCAFFOLD TUBE 500	1.9



Swivel Couplers

50 x 50 Swivel Couplers attach Scaffold Tubes to Standards in any direction. 38 x 48 Swivel Couplers attach Scaffold Tubes to Base Jacks.

CODE	DESCRIPTION	MASS(kg)
1905059	50 X 50 SWIVEL COUPLER	1.5
1950100	38 X 48 SWIVEL COUPLER	1.1



Band and Plates

Band and Plates are used to attach Scaffold Tubes to Standards at 90°.

CODE	DESCRIPTION	MASS(kg)
1805054	BAND BACK PLATE & EYEBOLT	0.7
1905008	50 X 50 BAND	1.6



Diagonal Braces

Kwik-Stage Diagonal Braces are used to brace support work structures.

CODE	DESCRIPTION	MASS(kg)
1105063	DIAGONAL BRACE 2500 X 2500	12.6
1105060	DIAGONAL BRACE 2500 X 2000	11.6
1105062	DIAGONAL BRACE 2000 X 2000	10.4
1105059	DIAGONAL BRACE 2000 X 1219	8.9
1105061	DIAGONAL BRACE 1500 X 1500	8.2



Application - Handrails

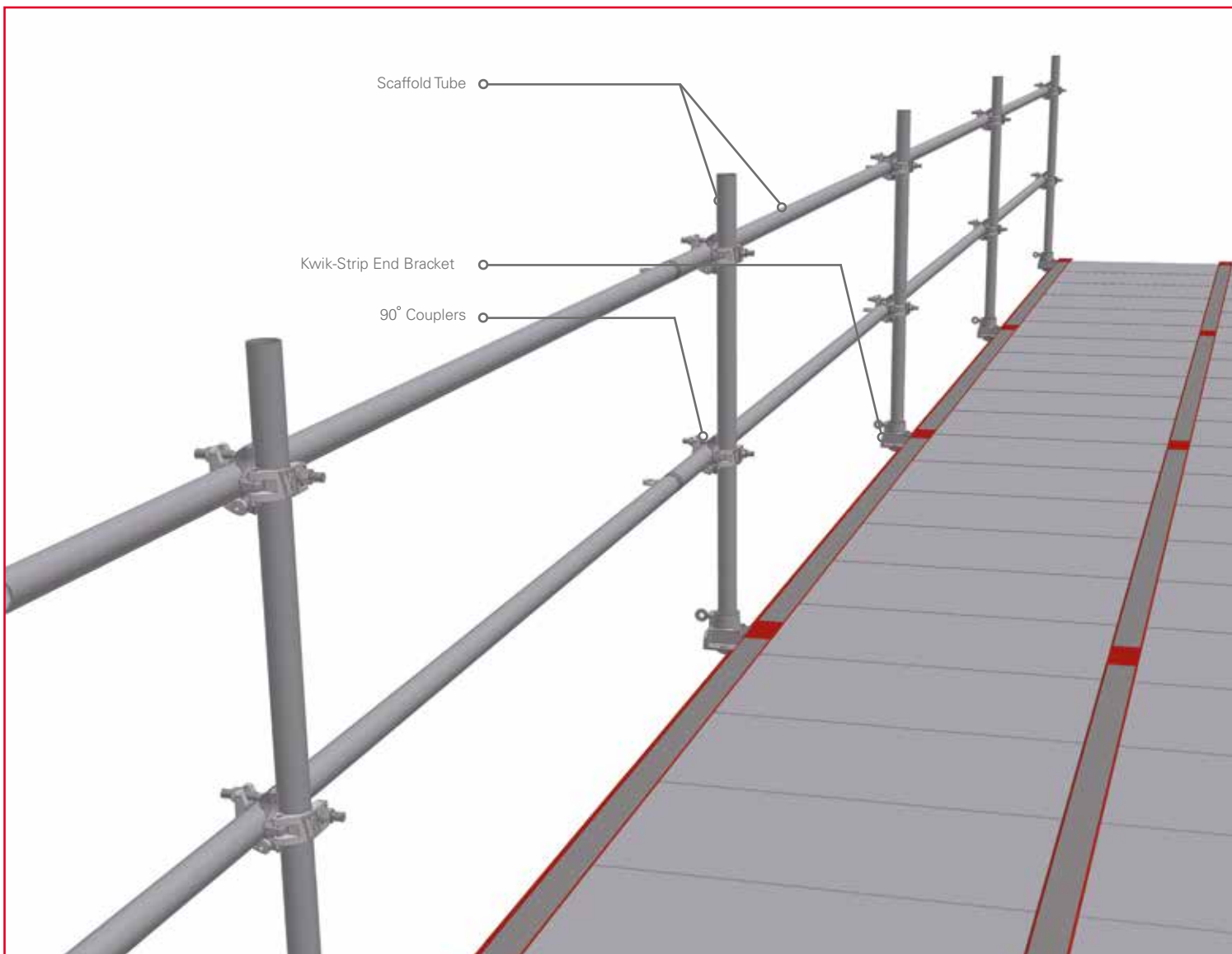

International Branches

Ghana - Accra

Plot 29, Off Spintex Road, Tema
Motorway Industrial Area,
Accra, Ghana
Tel +233 30397 3722 /
+233 20868 1651

Kenya - Nairobi

Plot 15081/5/27 Old Airport North
Road, Nairobi, Kenya
Tel +254 724 004 781 /
+254 718 220 412

Mauritius - Port Louis

Anse Courtois Street, Montebello,
Pailles, Mauritius
Tel +230 286 6175 /
+230 5940 2551

Mozambique - Palma

N'Cumbi Road No. R762,
Palma, Mozambique
Tel +258 86 109 6443 /
+258 84 774 3788

Mozambique - Pemba

Estrada Nacional EN106, Muxara,
Pemba, Cabo Delgado, Mozambique
Tel: +258 84 312 4146

Namibia - Swakopmund

608 Nelson Mandela Avenue,
Swakopmund, Namibia
Tel +264 64 46 3677 /
+264 64 46 2720

Namibia - Windhoek

Cnr Nickle & Michelle McClean Street,
Prosperita, Windhoek, Namibia
Tel +264 61 425 350 /
+264 081 164 9806

Swaziland - Matsapha

Lot 814, King Mswati III Ave,
Matsapha, Swaziland
Tel +268 25 18 8360 /
+268 7668 5337

Tanzania - Dar es Salaam

Cnr Mwaikibaki Road & Kilimani
Close, Plot 1034/5 Mbezi Kawe,
Dar es Salaam, Tanzania
Tel +255 75 638 8115 /
+255 74 299 8022

Zambia - Kitwe

Plot 16, Karibu Business Park,
Kitwe, Zambia
Tel +260 966 880009 /
+ 260966 923 854

Zambia - Lusaka

Plot 397 A/3/B Kufue Road,
Lusaka, Zambia
Tel +260 968 491061 /
+ 260966 923 854

South African Branches

Ballito

Labora Terra Industrial Park,
Shakas Rock Road, Umhlali,
Ballito, KwaZulu Natal
Tel +27 (0) 32 947 9430

Bloemfontein

26 Tibbie Visser Street, Estoire
Small Holdings District,
Bloemfontein, Free State
Tel +27 (0) 51 432 5555

Cape Town

8 Rondevallei Road, Hagley,
Kuilsrivier, Western Cape
Tel +27 (0) 21 528 6500

Durban South

16 Stroude Place, Isipingo,
KwaZulu Natal
Tel +27 (0) 31 902 2677

East London

5 Ray Craib Crescent,
Beacon Bay, Eastern Cape
Tel +27 (0) 43 748 2558

Gauteng

Poplar Crescent, Lords View
Industrial Park, Klipfontein,
Chloorkop X66, Gauteng
Tel +27 (0) 10 601 6313

George

10 Ring Road, George Industrial,
George, Western Cape
Tel +27 (0) 44 695 0294

Kathu

33 Kalk Street, Industrial Area,
Kathu, Northern Cape
Tel +27 (0) 53 723 2194

Lephalale

Rietspruit Plot 23, Portion 46,
Witkop Road, Lephalale, Limpopo
Tel +27 (0) 14 763 7982

Margate

Industrial Road, Margate,
KwaZulu Natal
Tel +27 (0) 39 317 1708

Nelspruit

Erf 379, Rocky Drift,
Mpumalanga
Tel +27 (0) 13 758 1036

Newcastle

6 Schonland Street, Riverside
Industrial Area, Newcastle,
KwaZulu Natal
Tel +27 (0) 34 375 7697

Pietermaritzburg

Market Road Ext, Mkondeni,
Pietermaritzburg, KwaZulu Natal
Tel +27 (0) 33 346 1767

Polokwane

62 Goud Street, Laboria,
Polokwane, Limpopo
Tel +27 (0) 15 293 0450

Port Elizabeth

4 Kendle Street, Neave Industrial
Area, Eastern Cape
Tel +27 (0) 41 453 2317

Richards Bay

111 Alluminia Alley, Alton Industrial
North, KwaZulu Natal
Tel +27 (0) 35 751 1140

Rustenburg

3 Ferro Street, Rustenburg,
North West Province
Tel +27 (0) 14 538 2540

Vereeniging

Cnr Telford & Van Riebeeck Street,
Duncanville, Gauteng
Tel +27 (0) 16 455 1611

Witbank

TP66 Geodesic Crescent, Marelden
Ext 3, Techno Park, Witbank,
Mpumalanga
Tel +27 (0) 13 690 2833

Head Office

181 Barbara Road,
Elandsfontein, Gauteng
PO Box 669, Isando, 1660
Tel +27 (0) 11 842 4000

 **kwik-strip**

Waco Africa / Head Office: PO Box 669, Isando, 1600.
181 Barbara Road, Elandsfontein. Tel: 011 842 4000

 **form-scaff**

Technical Advice Centre 0800 20 50 29 / 011 842 4011
www.formscaff.com