

Product Catalogue
Support Work

FS kwik-stage



FS form-scaff

Formwork & Scaffolding
Solutions

We are
WACO



Form-Scaff is South Africa's leading supplier of formwork, falsework and scaffolding to the construction and civil engineering industries. Form-Scaff not only manufactures, hires and sells world-class products, but also provides the design skills, technical advice and support that comes with having 50 years experience and more than 30 branches locally and internationally.

We are Waco International

Form-Scaff is part of Waco International, a focused equipment rental and industrial services business with operations in Africa (South Africa and other sub-Saharan African countries), Australasia (Australia and New Zealand) and the United Kingdom.

The Group provides services in the areas of formwork, shoring and scaffolding, insulation, painting and blasting, hydraulics and suspended access platforms, relocatable modular buildings, portable sanitation products and integrated hygiene services.

Disclaimer:

Copyright in this catalogue vests in Form-Scaff, a division of Waco Africa (Proprietary) Limited ("Form-Scaff") and extends inter alia, to the making of copies in whole or in part without the prior written consent of Form-Scaff.

While every effort has been made to ensure the accuracy of the information in this catalogue, we cannot accept responsibility for any errors which may occur as a result of reliance on the contents of this catalogue and are not liable for any loss of any nature that may be incurred as a result of such reliance. Details of any of the products may change without prior notice.

The customer must ensure that 'good practice' is adopted on site by competent persons and that the products shown in this catalogue are erected, used and stripped in accordance with the relevant Codes of Practice and the OHS Act and Regulations 85 of 1993. This catalogue does not contain any design detail but lists and depicts the items available under this product range. The responsibility for design is the responsibility of the customer.

Note: The colours used in this document are for illustrative purposes only and may differ on actual products

Contents



kwik-stage

Page 2 Kwik-Stage Overview

Page 3 General Assembly

Page 4 Standards & Ledgers

Page 6 Top Jacks

Page 9 Fittings

Page 10 Bracing

Page 11 Beam Bearers

Contact Details

Page 13 Head Office & Branches

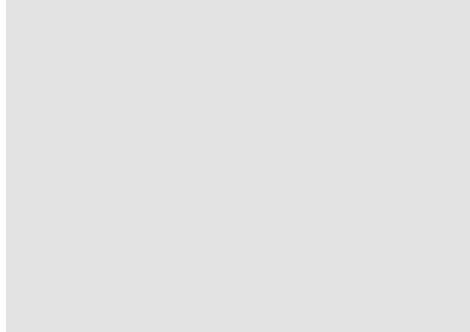
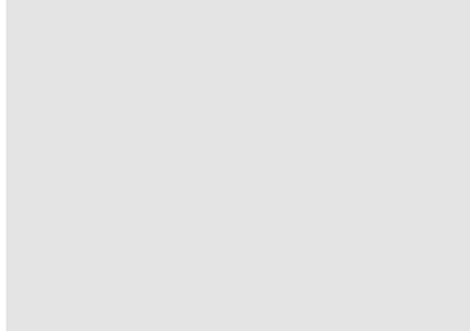



kwik-stage



Kwik-Stage Supportwork

Form-Scaff's Kwik-Stage system has been in use from the mid 1970's and almost 40 years later is still the system of choice for supporting concrete soffits.

Versatile, robust and cost effective, Kwik-Stage has proven its ability to cope with local conditions.

System Features

- 42kN system.
- Modular design ensures ease of use.
- Versatile height and width configurations.
- Safe working platforms.
- Compatible with the Super-Scaff system.
- Conforms to all South African standards and regulations.



General Assembly

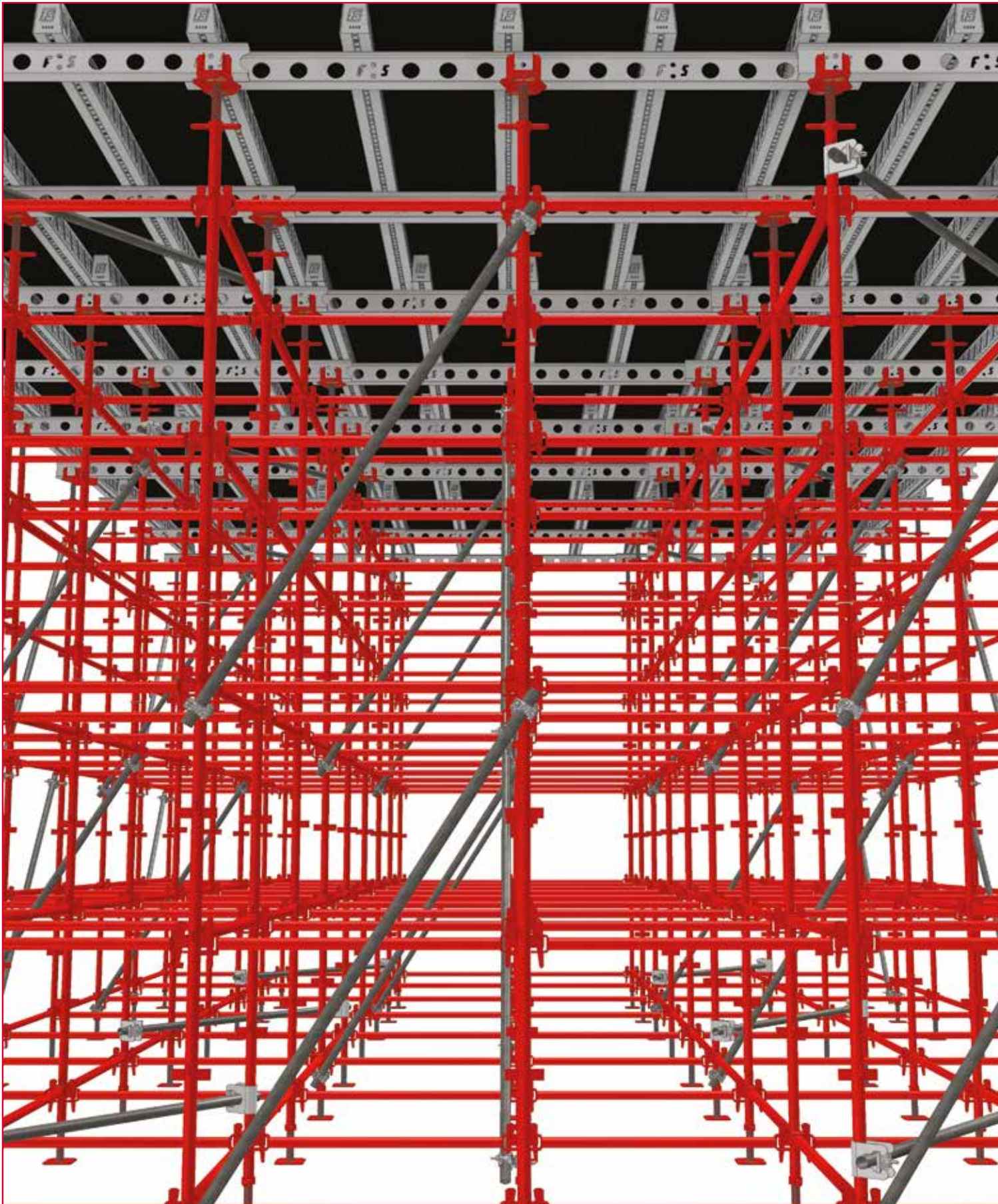

Standards & Ledgers

Jacks and Base Plates

Kwik-Stage Base Jacks are inserted into the ends of Kwik-Stage Standards to provide the required vertical height adjustment.

Kwik-Stage Base Plates are inserted into the bottom end of Kwik-Stage Standards to spread the load onto the bearing surface.

CODE	DESCRIPTION	MASS(kg)
0135302	KWIK-STAGE BT BASE PLATE	1.6
0140335	KWIK-STAGE 610 R/O BT BASE JACK	4.2



Kwik-Stage Standards

Kwik-Stage Standards make-up the vertical supports for bearers, formwork and access.

CODE	DESCRIPTION	MASS(kg)
1105005	KWIK-STAGE STANDARD 3000	15.5
1105004	KWIK-STAGE STANDARD 2500	12.9
1105003	KWIK-STAGE STANDARD 2000	10.3
1105002	KWIK-STAGE STANDARD 1500	7.7
1105001	KWIK-STAGE STANDARD 1000	5.2
1105000	KWIK-STAGE STANDARD 500	2.6
1105045	KWIK-STAGE STANDARD 250 C/W SOCKET	2.6



Connectors

Kwik-Stage Connectors are used to locate Standards on top of each other.

CODE	DESCRIPTION	MASS(kg)
0145341	KWIK-STAGE CONNECTOR	0.4



Kwik-Stage Ledgers

Kwik-Stage Ledgers are horizontal members used to keep the Kwik-Stage Standards in a vertical position.

CODE	DESCRIPTION	MASS(kg)
1105021	KWIK-STAGE LEDGER 2500	9.0
1105022	KWIK-STAGE LEDGER 2000	7.3
1105018	KWIK-STAGE LEDGER 1800	6.6
1105034	KWIK-STAGE LEDGER 1600	6.0
1105023	KWIK-STAGE LEDGER 1500	5.7
1105024	KWIK-STAGE LEDGER 1294	5.0
1105025	KWIK-STAGE LEDGER 1219	4.7
1105026	KWIK-STAGE LEDGER 1200	4.7
1105027	KWIK-STAGE LEDGER 1000	3.4
1105029	KWIK-STAGE LEDGER 900	3.1
1105031	KWIK-STAGE LEDGER 800	2.9
1105037	KWIK-STAGE LEDGER 700	2.6
1105032	KWIK-STAGE LEDGER 600	2.4





Bridging Ledgers

Kwik-Stage Bridging Ledgers are used to bridge between two Standards, reducing the number of Standards required.

CODE	DESCRIPTION	MASS(kg)
1105106	KWIK-STAGE BRIDGING LEDGER 1800	21.3

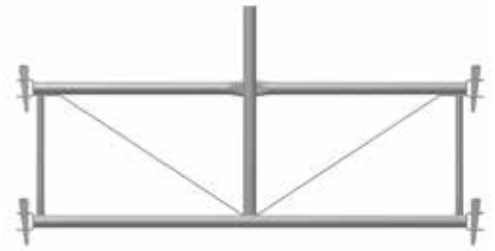

Application - Bridging Ledgers

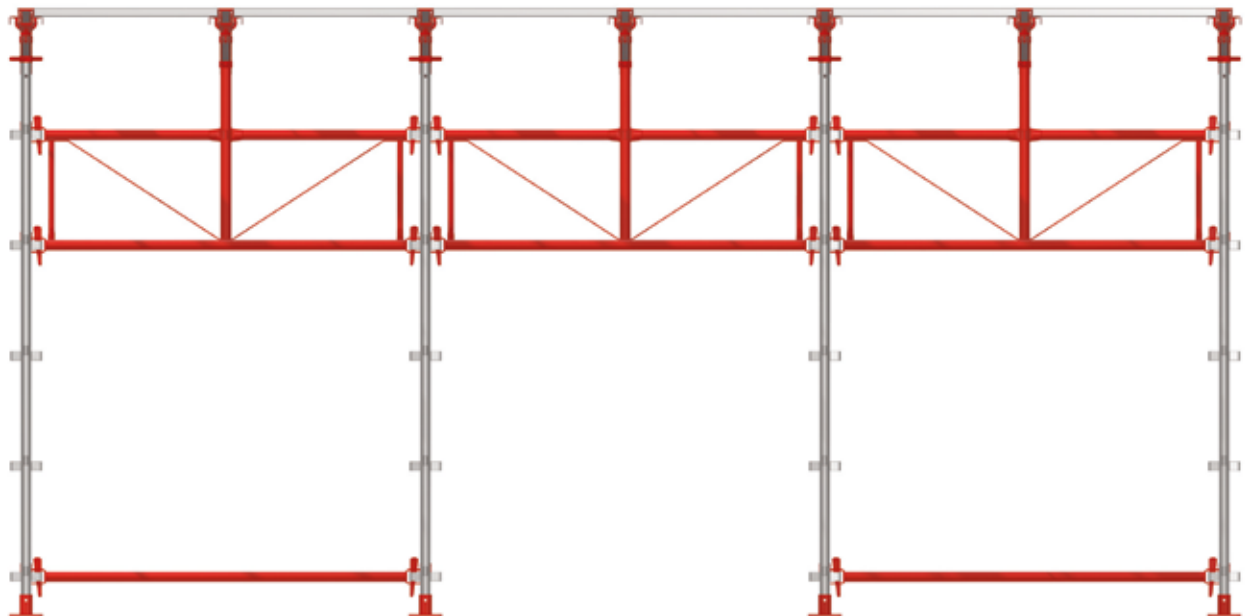

Top Jacks

U-Heads

U-Heads support bearers on top of Kwik-Stage including timber and steel bearers.

CODE	DESCRIPTION	MASS(kg)
0140326	KWIK-STAGE 610 TUBE R/O JACK	7.2
0140322	KWIK-STAGE 457 TUBE R/O JACK	6.5
0135306	KWIK-STAGE U-HEAD SPIGOT	4.0

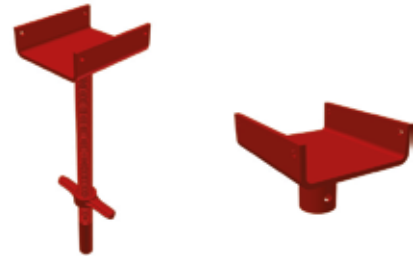

J-Heads

J-Heads support bearers on top of Kwik-Stage including timber and steel bearers.

CODE	DESCRIPTION	MASS(kg)
0140325	KWIK-STAGE 610 R/O J.H JACK	4.7
0140321	KWIK-STAGE 457 R/O J.H JACK	4.0
0135303	KWIK-STAGE J-HEAD SPIGOT	1.5

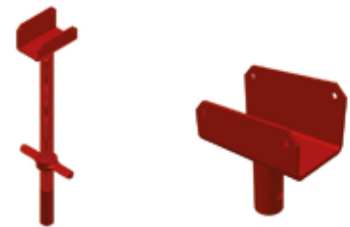

Fork Heads

Multi-Form Fork Heads can be used at the top of the Kwik-Stage BT Base Jack or Swivel Jack. Main Bearers centrally positioned over the Jacks.

CODE	DESCRIPTION	MASS(kg)
1130016	MULTI-FORM FORK-HEAD	1.8

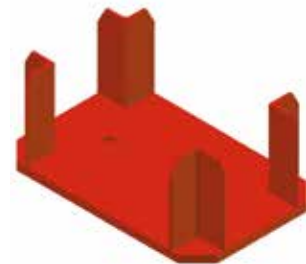

Swivel Jacks

Kwik-Stage Swivel Jacks are inserted into the ends of Kwik-Stage Standards when used on sloping surfaces to provide the required vertical height adjustment.

CODE	DESCRIPTION	MASS(kg)
0140350	KWIK-STAGE SWIVEL BASE JACK (SOLID)	10.7





Application - U-Heads

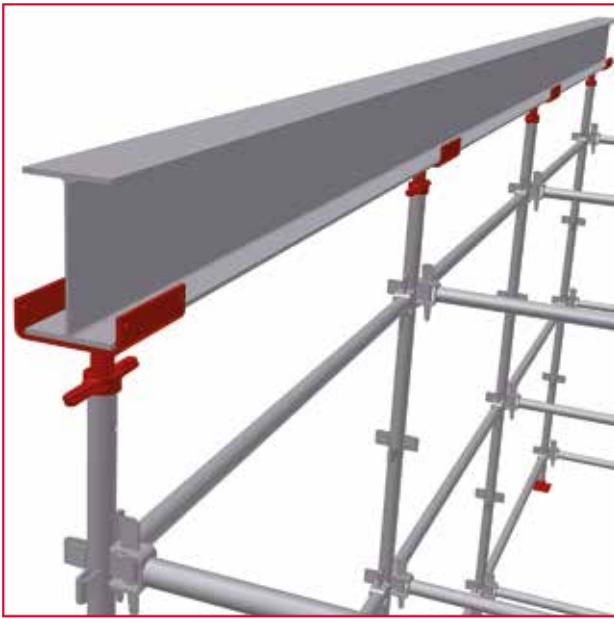

Application - J-Heads



Application - Fork Heads



Application - Swivel Jack

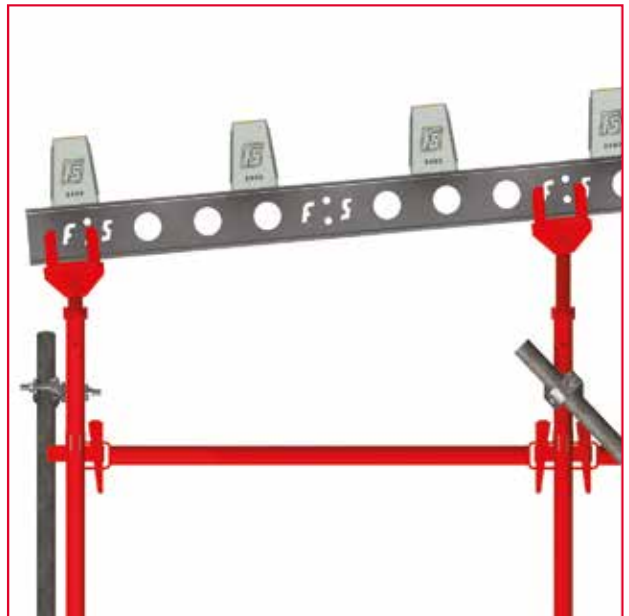

Application - Sloping Surfaces

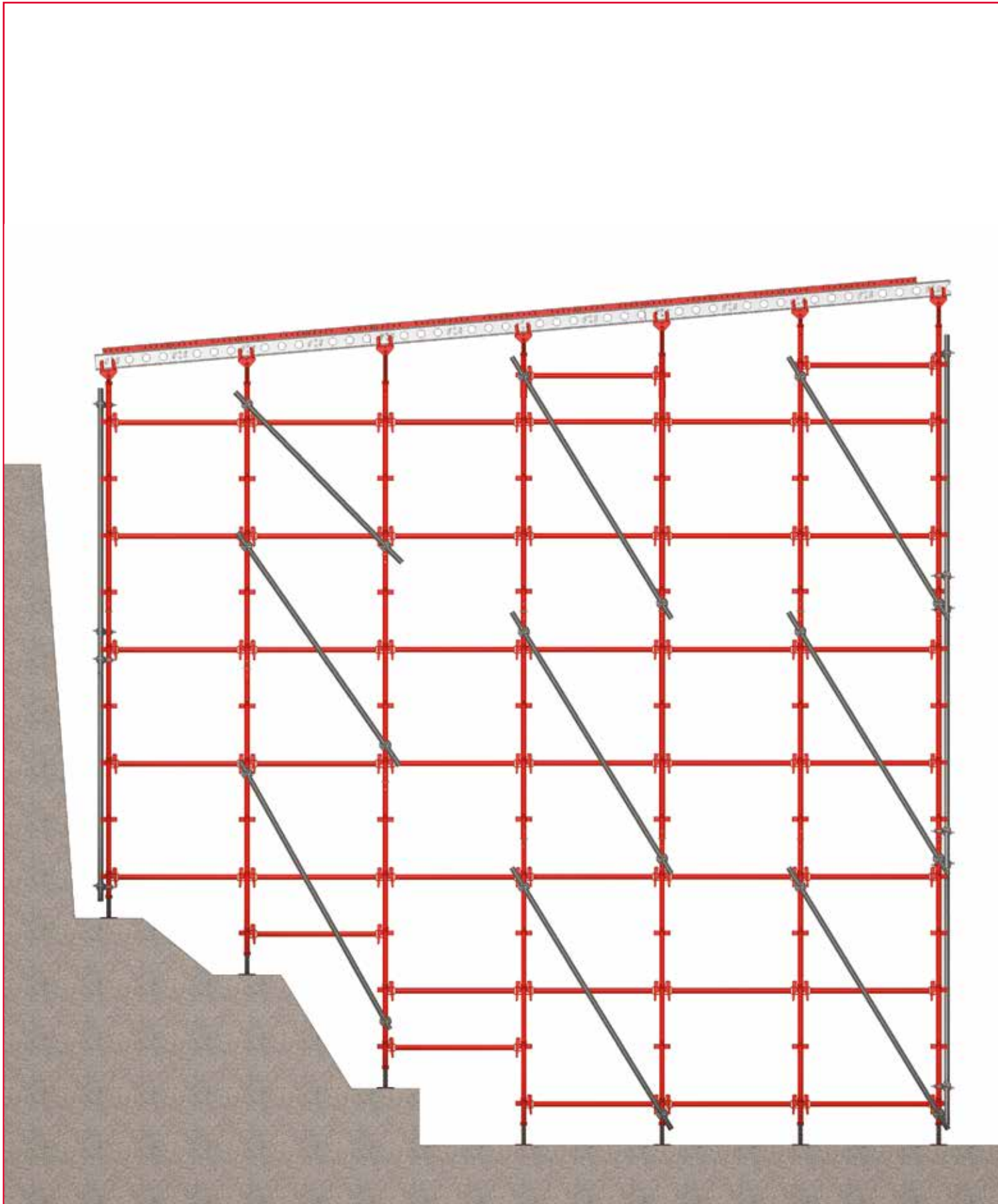

90° Couplers

90° Couplers are used to attach a Scaffold Tube to a Standard at 90°.

CODE	DESCRIPTION	MASS(kg)
1905016	50 X 50 COUPLER 90 DEGREE	1.5



Flange Couplers

Flange Couplers attach a Scaffold Tube to the flange of a channel iron or I beam.

CODE	DESCRIPTION	MASS(kg)
1905067	COUPLER (FLANGE TYPE)	1.1



DH Couplers

DH Couplers are used to connect a Scaffold Tube to a Standard at 90°.

CODE	DESCRIPTION	MASS(kg)
1905015	COUPLER DH	1.4



Internal Spigot Couplers

Internal Spigot Couplers are used to join two Scaffold Tubes end to end.

CODE	DESCRIPTION	MASS(kg)
1905019	INTERNAL SPIGOT COUPLER 50	1.1



Diagonal Braces

Kwik-Stage Diagonal Braces are used to brace Kwik-Stage.

CODE	DESCRIPTION	MASS(kg)
1105063	DIAG BRACE 3535 C/C 2500 X 2500	12.6
1105060	DIAG BRACE 3202 C/C 2500 X 2000	11.6
1105062	DIAG BRACE 2828 C/C 2000 X 2000	10.4
1105059	DIAG BRACE 2342 C/C 2000 X 1219	8.9
1105061	DIAG BRACE 2121 C/C 1500 X 1500	8.2



Scaffold Tubes

Scaffold Tubes are used for a variety of applications in support work and access scaffolding, i.e. bracing, lacing, handrails etc.

CODE	DESCRIPTION	MASS(kg)
1905151	SCAFFOLD TUBE 6100	22.7
1905098	SCAFFOLD TUBE 5500	20.5
1905097	SCAFFOLD TUBE 5000	18.6
1905096	SCAFFOLD TUBE 4500	16.7
1905095	SCAFFOLD TUBE 4000	14.9
1905094	SCAFFOLD TUBE 3500	13.0
1905093	SCAFFOLD TUBE 3000	11.2
1905092	SCAFFOLD TUBE 2500	9.3
1905091	SCAFFOLD TUBE 2000	7.4
1905090	SCAFFOLD TUBE 1500	5.6
1905089	SCAFFOLD TUBE 1000	3.7
1905088	SCAFFOLD TUBE 500	1.9



Swivel Couplers

50 x 50 Swivel Couplers attach Scaffold Tubes to Standards in any direction. 38 x 48 Swivel Couplers attach Scaffold Tubes to Base Jacks.

CODE	DESCRIPTION	MASS(kg)
1905059	50 X 50 SWIVEL COUPLER	1.5
1950100	38 X 48 SWIVEL COUPLER	1.1



Band and Plates

Band and Plates are used to attach Scaffold Tubes to Standards at 90°.

CODE	DESCRIPTION	MASS(kg)
1805054	BAND BACK PLATE & EYEBOLT	0.7
1905008	50 X 50 BAND	1.6



Base Pedestals

Kwik-Stage Base Pedestals are used for slab edge and ring beam support by cantilevering 150mm past the lower level slab.

CODE	DESCRIPTION	MASS(kg)
1105092	900 BASE PEDESTAL	16.1
1105095	1800 BASE PEDESTAL	52.1

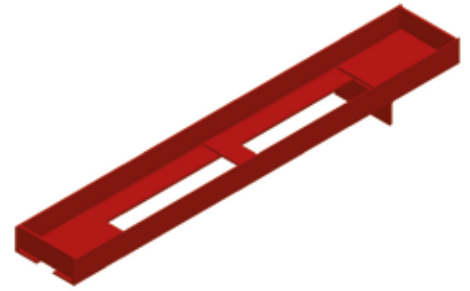

Beam Bearers

Kwik-Stage Beam Bearers are supported on two Kwik-Strip Beams. The Beam Bearer supports an Econo-Form Panel as a Beam soffit. The Beam Stay plumbs the Beam Side Panel.

CODE	DESCRIPTION	MASS(kg)
1105091	BEAM BEARER	16.0
1105093	BEAM STAY	6.0



Application - Beams Bearers

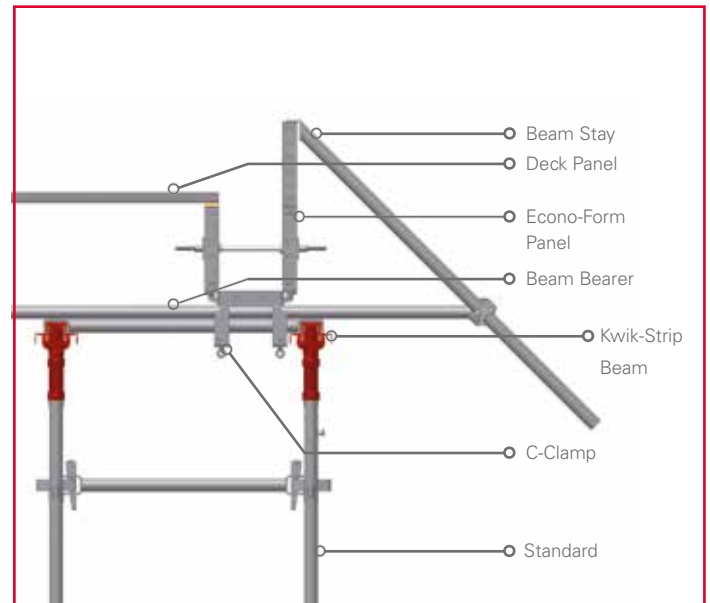
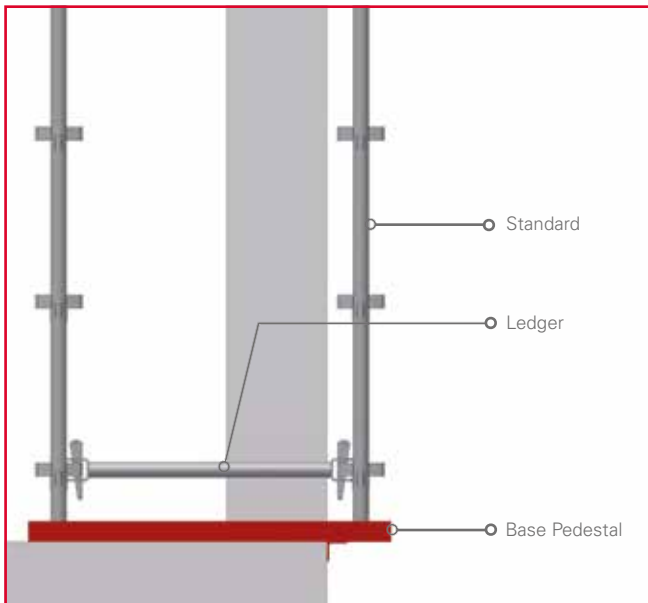

Application - Beam Bearers

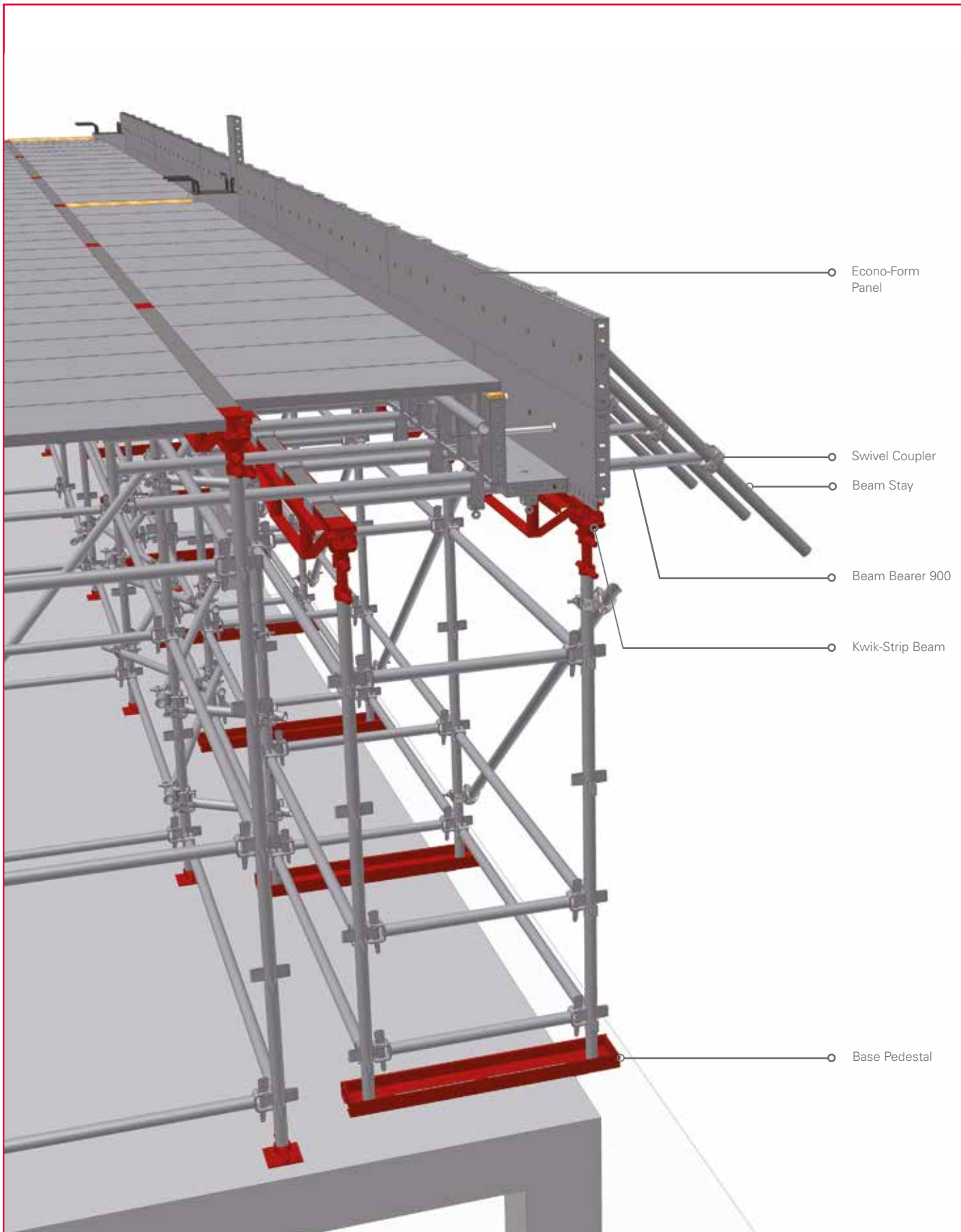

International Branches

Ghana - Accra

Plot 29, Off Spintex Road, Tema
Motorway Industrial Area,
Accra, Ghana
Tel +233 30397 3722 /
+233 20868 1651

Kenya - Nairobi

Plot 15081/5/27 Old Airport North
Road, Nairobi, Kenya
Tel +254 724 004 781 /
+254 718 220 412

Mauritius - Port Louis

Anse Courtois Street, Montebello,
Pailles, Mauritius
Tel +230 286 6175 /
+230 5940 2551

Mozambique - Palma

N'Cumbi Road No. R762,
Palma, Mozambique
Tel +258 86 109 6443 /
+258 84 774 3788

Mozambique - Pemba

Estrada Nacional EN106, Muxara,
Pemba, Cabo Delgado, Mozambique
Tel: +258 84 312 4146

Namibia - Swakopmund

608 Nelson Mandela Avenue,
Swakopmund, Namibia
Tel +264 64 46 3677 /
+264 64 46 2720

Namibia - Windhoek

Cnr Nickle & Michelle McClean Street,
Prosperita, Windhoek, Namibia
Tel +264 61 425 350 /
+264 081 164 9806

Swaziland - Matsapha

Lot 814, King Mswati III Ave,
Matsapha, Swaziland
Tel +268 25 18 8360 /
+268 7668 5337

Tanzania - Dar es Salaam

Cnr Mwaikibaki Road & Kilimani
Close, Plot 1034/5 Mbezi Kawe,
Dar es Salaam, Tanzania
Tel +255 75 638 8115 /
+255 74 299 8022

Zambia - Kitwe

Plot 16, Karibu Business Park,
Kitwe, Zambia
Tel +260 966 880009 /
+ 260966 923 854

Zambia - Lusaka

Plot 397 A/3/B Kufue Road,
Lusaka, Zambia
Tel +260 968 491061 /
+ 260966 923 854

South African Branches

Ballito

Labora Terra Industrial Park,
Shakas Rock Road, Umhlali,
Ballito, KwaZulu Natal
Tel +27 (0) 32 947 9430

Bloemfontein

26 Tibbie Visser Street, Estoire
Small Holdings District,
Bloemfontein, Free State
Tel +27 (0) 51 432 5555

Cape Town

8 Rondevallei Road, Hagley,
Kuilsrivier, Western Cape
Tel +27 (0) 21 528 6500

Durban South

16 Stroude Place, Isipingo,
KwaZulu Natal
Tel +27 (0) 31 902 2677

East London

5 Ray Craib Crescent,
Beacon Bay, Eastern Cape
Tel +27 (0) 43 748 2558

Gauteng

Poplar Crescent, Lords View
Industrial Park, Klipfontein,
Chloorkop X66, Gauteng
Tel +27 (0) 10 601 6313

George

10 Ring Road, George Industrial,
George, Western Cape
Tel +27 (0) 44 695 0294

Kathu

33 Kalk Street, Industrial Area,
Kathu, Northern Cape
Tel +27 (0) 53 723 2194

Lephalale

Rietspruit Plot 23, Portion 46,
Witkop Road, Lephalale, Limpopo
Tel +27 (0) 14 763 7982

Margate

Industrial Road, Margate,
KwaZulu Natal
Tel +27 (0) 39 317 1708

Nelspruit

Erf 379, Rocky Drift,
Mpumalanga
Tel +27 (0) 13 758 1036

Newcastle

6 Schonland Street, Riverside
Industrial Area, Newcastle,
KwaZulu Natal
Tel +27 (0) 34 375 7697

Pietermaritzburg

Market Road Ext, Mkondeni,
Pietermaritzburg, KwaZulu Natal
Tel +27 (0) 33 346 1767

Polokwane

62 Goud Street, Laboria,
Polokwane, Limpopo
Tel +27 (0) 15 293 0450

Port Elizabeth

4 Kendle Street, Neave Industrial
Area, Eastern Cape
Tel +27 (0) 41 453 2317

Richards Bay

111 Alluminia Alley, Alton Industrial
North, KwaZulu Natal
Tel +27 (0) 35 751 1140

Rustenburg

3 Ferro Street, Rustenburg,
North West Province
Tel +27 (0) 14 538 2540

Vereeniging

Cnr Telford & Van Riebeeck Street,
Duncanville, Gauteng
Tel +27 (0) 16 455 1611

Witbank

TP66 Geodesic Crescent, Marelden
Ext 3, Techno Park, Witbank,
Mpumalanga
Tel +27 (0) 13 690 2833

Head Office

181 Barbara Road,
Elandsfontein, Gauteng
PO Box 669, Isando, 1660
Tel +27 (0) 11 842 4000

 **kwik-stage**

Waco Africa / Head Office: PO Box 669, Isando, 1600.
181 Barbara Road, Elandsfontein. Tel: 011 842 4000

 **form-scaff**

Technical Advice Centre 0800 20 50 29 / 011 842 4011
www.formscaff.com