

# **form-scaff**



**columns**



**Product Catalogue 2014**



Form-Scaff is South Africa's leading supplier of formwork, falsework and scaffolding to the construction and civil engineering industries. Form-Scaff not only manufactures, hires and sells world-class products, but also provides the design skills, technical advice and support that comes with having 50 years experience and more than 30 branches locally and internationally.

This indigenous expertise is complemented by the international depth and breadth of its holding company, Waco International, a leading global commercial and industrial service business focusing on the manufacturing, rental and sale of formwork, falsework and scaffolding equipment as well as the burgeoning re-locatable and modular buildings industry. Waco International operates in Africa, the UK, Australia, New Zealand and Chile.

Form-Scaff is a division of Waco Africa (Pty) Ltd, a joint venture company owned by Waco International and respected local black empowerment company, Kagiso.

Formwork, Shoring & Scaffolding

WACO WORLDWIDE

Modular & Relocatable Buildings

  
 Australia  
New Zealand

  
 New Zealand

  
 Ghana  
Madagascar  
Mozambique  
Namibia  
South Africa

  
 United Kingdom

  
 South Africa

  
 South Africa



  
 New Zealand

  
 South Africa

  
 Chile  
Ghana  
Mauritius  
Mozambique  
Namibia  
South Africa  
Swaziland  
Zambia

  
 Australia

**Disclaimer:**  
Copyright in this catalogue vests in Form-Scaff, a division of Waco Africa (Proprietary) Limited ("Form-Scaff") and extends inter alia, to the making of copies in whole or in part without the prior written consent of Form-Scaff.

While every effort has been made to ensure the accuracy of the information in this catalogue, we cannot accept responsibility for any errors which may occur as a result of reliance on the contents of this catalogue and are not liable for any loss of any nature that may be incurred as a result of such reliance. Details of any of the products may change without prior notice.

The customer must ensure that 'good practice' is adopted on site by competent persons and that the products shown in this catalogue are erected, used and stripped in accordance with the relevant Codes of Practice and the OHS Act and Regulations 85 of 1993. This catalogue does not contain any design detail but lists and depicts the items available under this product range. The responsibility for design is the responsibility of the customer.

**Note:** The colours used in this document are for illustrative purposes only and may differ on actual products

# Contents



- Page 2** Column Boxes Overview
- Page 3** Column Boxes General Assembly
- Page 4** Circular and Rectangular Column Boxes
- Page 5** Column Box Sundry Items
- Page 6** Column Box Propping System
- Page 7** Column Box Ties
- Page 8** Column Box Application
- Page 9** Adjustable Column Box
- Page 10** Adjustable Column Box Application
- Page 11** Adjustable Column Box Sizes
- Page 12** Column Box Clamp Application

## Contact Details

- Page 13** Head Office & Branches

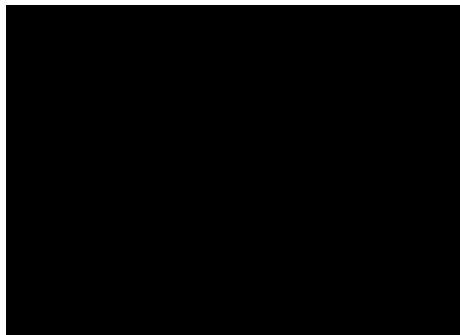



# columns



## Columns

Form-Scaff has been manufacturing and supplying various column box systems to contractors for the last 50 years. The systems have proven to be versatile and produce high class concrete surface finishes. Form-Scaff is able to produce any shape column boxes to suit the aesthetic and structural requirements of engineers & architects.

### System Features

- Quick and easy to assemble and strike.
- Easy to plumb.
- Components are lightweight and easy to manhandle.
- A large variety of shapes & sizes are available.
- Walers and soldiers are not required due to the robust built in stiffeners.
- The column boxes may be extended horizontally and or vertically to suit the customers requirements.
- Ties are only required when two or more column box panels are used side by side.
- The column boxes conform to all South African standards and regulations

## General Assembly

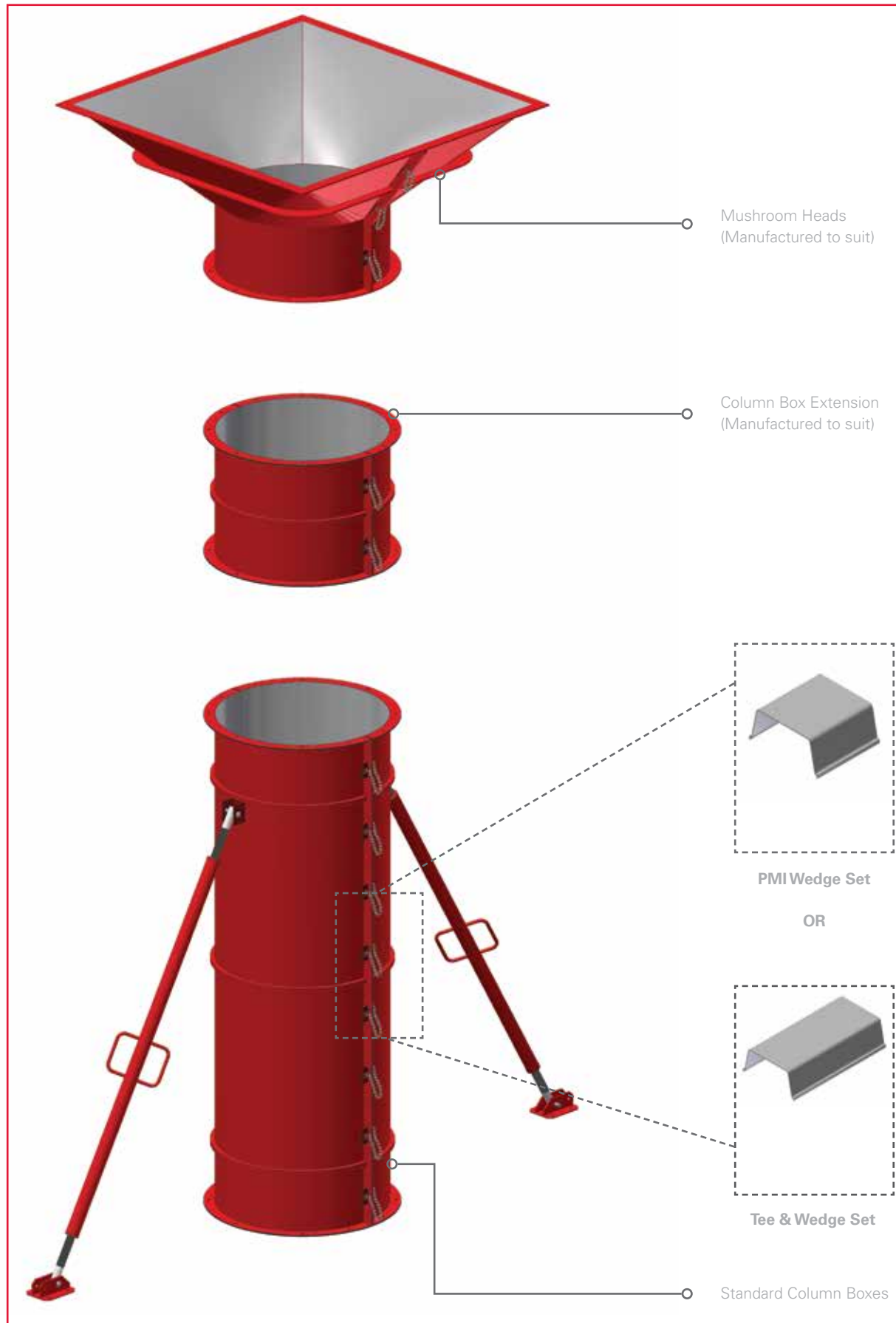

# Column Boxes

## Circular Column Boxes

Circular Column Boxes are used to form circular concrete columns and the bull-nose ends of concrete columns and walls.

CODE	DESCRIPTION	MASS(kg)
5705033	COLUMN BOX CIRCULAR 3000 x 600	202.5
5705034	COLUMN BOX CIRCULAR 3000 x 550	189.0
5705035	COLUMN BOX CIRCULAR 3000 x 500	175.4
5705036	COLUMN BOX CIRCULAR 3000 x 450	147.6
5705037	COLUMN BOX CIRCULAR 3000 x 400	134.6
5705038	COLUMN BOX CIRCULAR 3000 x 350	121.5
5705039	COLUMN BOX CIRCULAR 3000 x 300	108.5
5705157	COLUMN BOX CIRCULAR 3000 x 230	88.6

\* Other diameters and lengths are also available. Please contact your nearest branch for more information.



## Rectangular Column Boxes

Rectangular Column Boxes are used to form square or rectangular shaped concrete columns.

CODE	DESCRIPTION	MASS(kg)
5505027	COLUMN BOX A TYPE MAIN SIDE 3000 x 600	105.0
5510027	COLUMN BOX A TYPE SMALL SIDE 3000 x 600	85.1
5505029	COLUMN BOX A TYPE MAIN SIDE 3000 x 450	74.7
5510029	COLUMN BOX A TYPE SMALL SIDE 3000 x 450	59.0
5505031	COLUMN BOX A TYPE MAIN SIDE 3000 x 300	60.1
5510031	COLUMN BOX A TYPE SMALL SIDE 3000 x 300	44.4
5505032	COLUMN BOX A TYPE MAIN SIDE 3000 x 225	52.8
5510032	COLUMN BOX A TYPE SMALL SIDE 3000 x 225	37.1
5605017	COLUMN BOX C TYPE 3000 x 600	101.7
5605019	COLUMN BOX C TYPE 3000 x 450	83.4
5605022	COLUMN BOX C TYPE 3000 x 300	60.9
5605024	COLUMN BOX C TYPE 3000 x 230	53.2

\* Other widths and lengths are also available. Please contact your nearest branch for more information.  
Form-Scaff's Econo-Form Panels can also be used as column boxes when used in conjunction with the Column Clamps shown on pages 5 & 12. For details on Econo-Form, please refer to the Form-Scaff Econo-Form Product Catalogue.

A Type Column Boxes are only manufactured for sale.



Column Box A Type Main Side



Column Box A Type Small Side



Column Box C Type

### Plastic Buttons

Plastic Buttons are used to plug any unused tie holes.

CODE	DESCRIPTION	MASS(kg)
5127001	ADJUSTABLE COLUMN BOX PLASTIC BUTTON	0.02
2960811	BUTTON 18MM DIA	0.01



### Fillets

Fillets are used to chamfer the sharp corners of concrete columns.

CODE	DESCRIPTION	MASS(kg)
5520302	TRIANGULAR PLASTIC FILLET 25 x 25 (PER M)	0.2
5520305	TRIANGULAR STEEL FILLET 25 x 25 (HOLLOW)	1.0
5520307	TRIANGULAR PLASTIC FILLET 20 x 20 PUNCHED	0.3

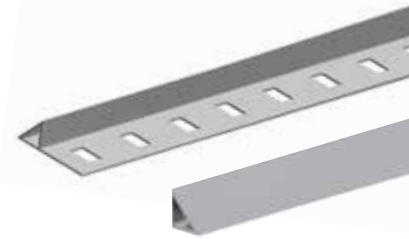

### PMI Wedge Sets

PMI Wedge Sets are used to join the edges of Column Boxes together.

CODE	DESCRIPTION	MASS(kg)
5595998	PMI WEDGE ASSEMBLY (WITH CHAIN)	0.5



### Wedge Sets

Wedge Sets are used to join the edges of Column Boxes together.

CODE	DESCRIPTION	MASS(kg)
2715555	KEY (HD)	0.1
2715556	WEDGE CURVED (HD)	0.1
2715552	WEDGE BENT CLIP	0.1
2715553	WEDGE ONLY (STRAIGHT)	0.1



### Column Clamp

Column Clamps are used as substitute walers when Econo-Form and Timber Column Boxes are used.

CODE	DESCRIPTION	MASS(kg)
5595996	COLUMN CLAMP ARM ONLY NO. 3 (WITH WEDGE)	7.0
5595995	COLUMN CLAMP ARM ONLY NO. 2 (WITH WEDGE)	4.4
5595994	COLUMN CLAMP ARM ONLY NO. 1 (WITH WEDGE)	3.6
5595997	COLUMN CLAMP WEDGE	0.3



# Propping

## Push-Pull Props

Tifa Push-Pull Props and Tifa Prop Ties are used to plumb the column boxes.

The Tifa Swivel Foot is used at the base of the Push-Pull Props and Prop Ties to connect the ends of the Props together.

Tifa Connecting Pins 16 x 90 complete with R-Clips are used to connect a Prop to the Column Box and to the Swivel Foot.

CODE	DESCRIPTION	MASS(kg)
5110100	TIFA PROPTIE H/D	8.4
5110022	TIFA PROP 5700 (PUSH-PULL)	63.3
5110201	TIFA PROP 4200 (PUSH-PULL)	23.0
5110024	TIFA PROP 3100 (PUSH-PULL)	16.6
5110007	TIFA PROP 2500 (PUSH-PULL)	14.0
5110008	TIFA SWIVEL FOOT 200 x 150	3.4
5110021	TIFA SWIVEL FOOT 300 x 250	7.6
5110090	TIFA CONNECTING PIN	0.2
5110059	R-CLIP	0.01

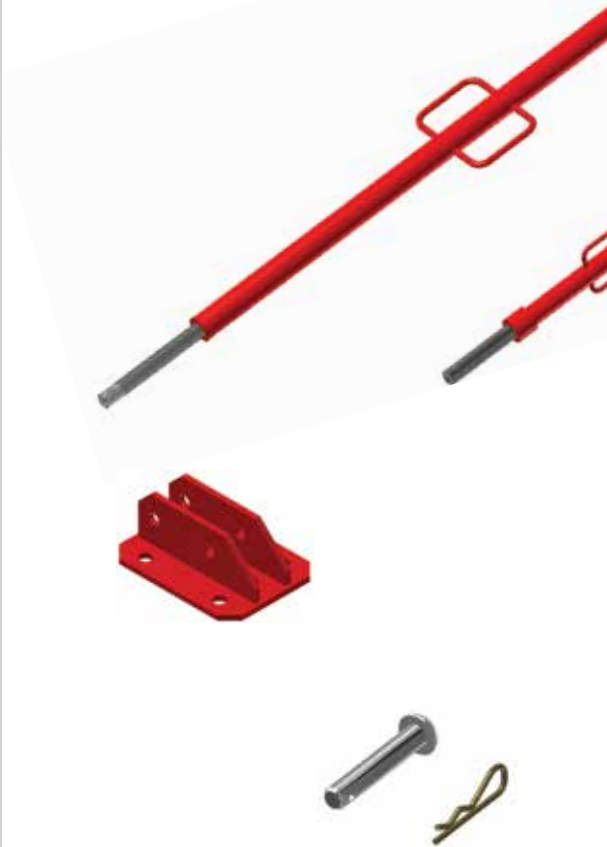

## Application - Prop Assembly

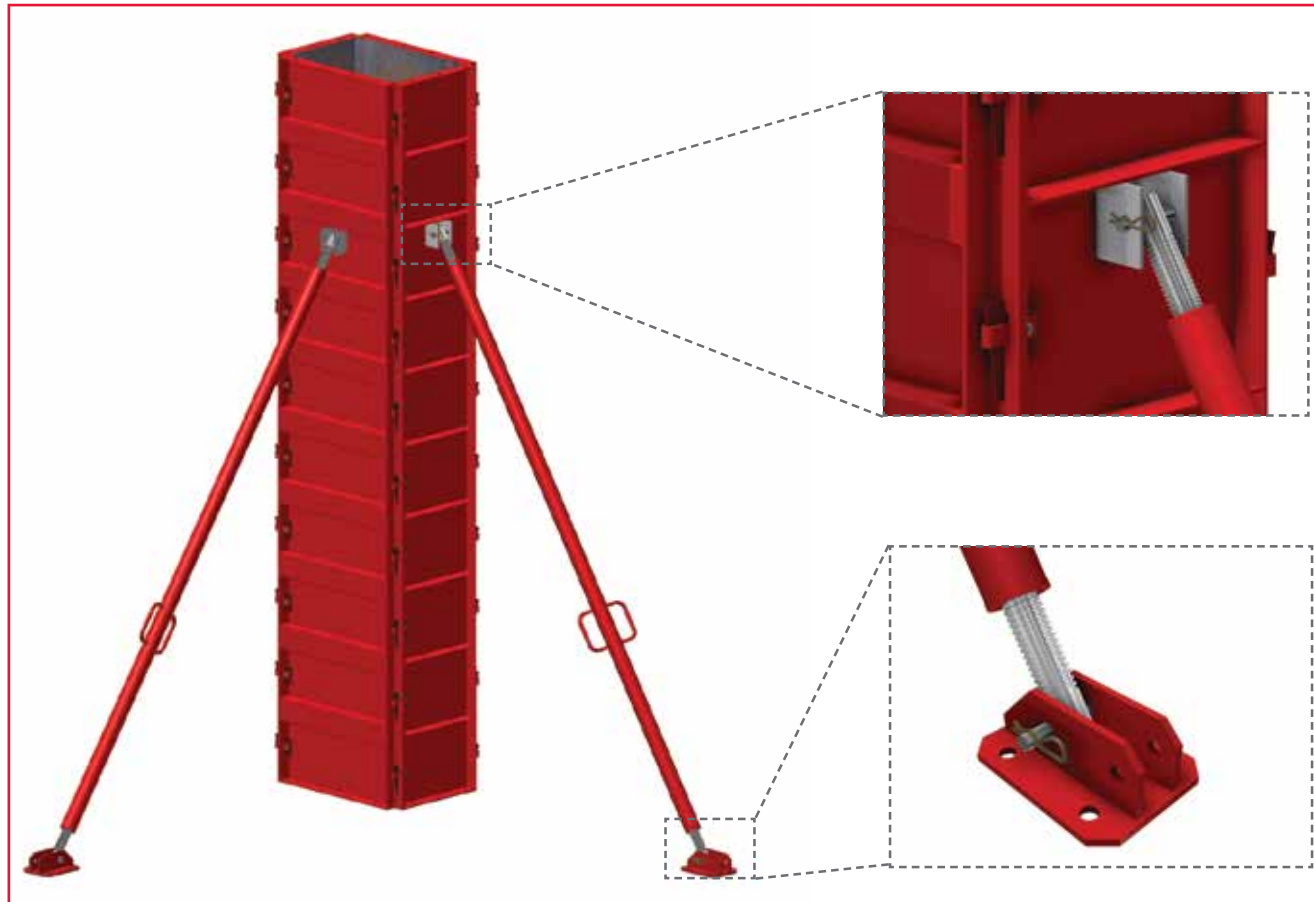



### Dywidag Tie Bar

Dywidag Ties are recoverable ties used through tie sleeves.

CODE	DESCRIPTION	MASS(kg)
5405077	DYWIDAG BAR 15mm 500	0.7
5405078	DYWIDAG BAR 15mm 1000	1.5
5405079	DYWIDAG BAR 15mm 1500	2.2
5405085	DYWIDAG BAR 15mm 2000	2.9
5405086	DYWIDAG BAR 15mm 2500	3.6
5405087	DYWIDAG BAR 15mm 3000	4.3
5405088	DYWIDAG BAR 15mm 3500	5.1
5405089	DYWIDAG BAR 15mm 4000	5.8
5405092	DYWIDAG BAR 15mm 4500	6.5
5405093	DYWIDAG BAR 15mm 5000	7.2
5405094	DYWIDAG BAR 15mm 5500	8.0
5405095	DYWIDAG BAR 15mm 6000	8.7



### Dywidag Nuts

The Dywidag Combi Wing Nut, Wing Nut & Washer or Dywidag Nut and Washer combinations can be used with the 15mm Dywidag Bar.

CODE	DESCRIPTION	MASS(kg)
5110032	TIFA WING NUT	1.8
5110035	WASHER 100 x 100 x 6	0.5
5110150	DYWIDAG COMBI WING NUT	1.1
5405076	DYWIDAG NUT 15 DIA	0.2



### Form-Tie Bar

Form-Ties are recoverable ties used through tie sleeves.

CODE	DESCRIPTION	MASS(kg)
5405070	FORM-TIE BAR F20 (PER M)	2.5
5405061	FORM-TIE BAR F16 (PER M)	1.6
5405072	FORM-TIE BAR F12 (PER M)	0.8



### Form-Tie Nut

Form-Tie Nuts are used each end of the Form-Tie.

CODE	DESCRIPTION	MASS(kg)
5405071	FORM-TIE NUT F20	0.5
5405062	FORM-TIE NUT F16	0.2
5405073	FORM-TIE NUT F12	0.1



### Form-Tie Pad & Washers

The Form-Tie Pad acts as a washer between the Form-Tie Nut and the Panel.

CODE	DESCRIPTION	MASS(kg)
5855602	80 x 80 x 6 WASHER	0.3
5405064	FORM-TIE PAD F8 (FOR F16TIE)	1.2

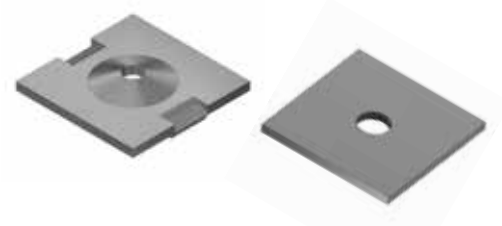

## Application - Column Types



Circular Column Box

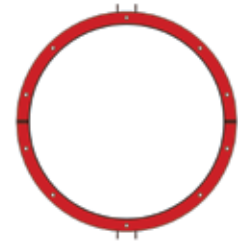

Rectangular Column Box

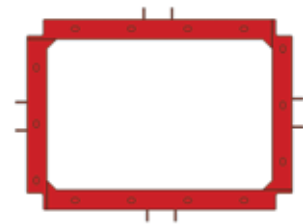

Bull-Nose Column Box

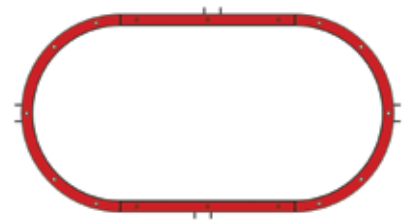

## Adjustable Column Panels

Adjustable Column Panels are used to form the vertical sides of concrete columns and provide a range of column sizes from 150mm to 600mm

CODE	DESCRIPTION	MASS(kg)
5127000	ADJUSTABLE COLUMN BOX PANEL 2700	1073
5127010	ADJUSTABLE COLUMN BOX PANEL 1200	56.0



## Working Platform

The Working Platform with foldable legs is attached onto the top of the Adjustable Column Panels.

CODE	DESCRIPTION	MASS(kg)
5127003	ADJUSTABLE COLUMN BOX PLATFORM	30.3



## Guardrail

The captive Guardrail may be is secured on three sides of the Working Platform.

CODE	DESCRIPTION	MASS(kg)
5125064	ADJUSTABLE COLUMN BOX GUARDRAIL	6.4



## Bolt Sets

The Bolt Sets are used to connect two Adjustable Column Panels together to form wider or taller Column Boxes.

CODE	DESCRIPTION	MASS(kg)
2966049	M20 x 40 BOLT, WASHER & NUT SET	0.1



## Adjustable Column Panel Fillet

Fillets are used to chamfer the sharp corners of concrete columns. The Adjustable Column Box (ACB) fillet simply clips onto the Column Panel

CODE	DESCRIPTION	MASS(kg)
5127004	A.C.B. PLASTIC CORNER FILLET (25 x 25)	0.3
5127001	ADJUSTABLE COLUMN BOX PLASTIC PLUG	0.02



## Application - Adjustable Column Box



## Application - Sizes

The Standard Size Columns that can be formed with a Single Panel Box are:  
 150mm, 230mm, 300mm, 350mm, 400mm, 450mm, 500mm, 550mm, 600mm.  
 Bigger (wider and/or higher) columns can be formed when bolting panels together.

Examples:

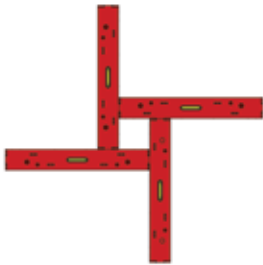

150mm x 150mm

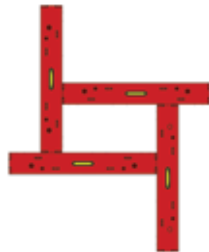

450mm x 230mm

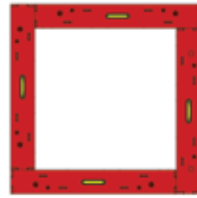

600mm x 600mm

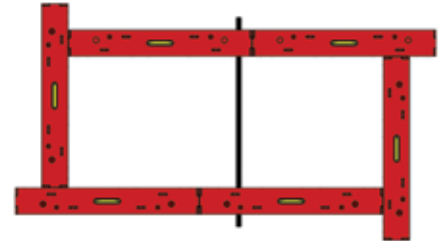

1100mm x 500mm

Typical Examples:

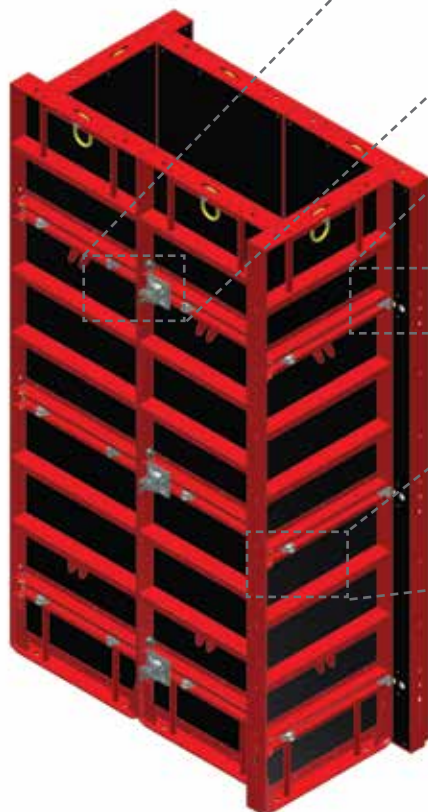

Dywag Tie



Captive T-Bolt



Captive Nut

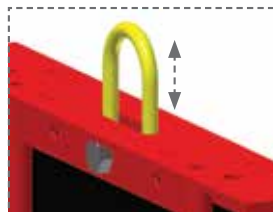

Retractable Lifting Point



# Application - Column Clamps

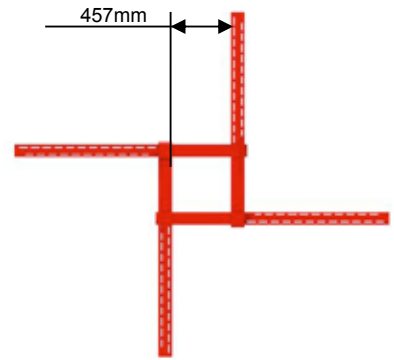
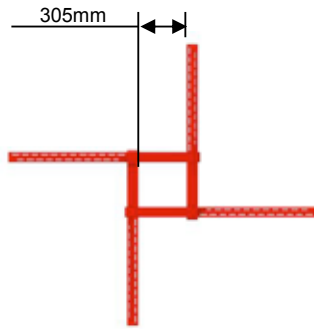
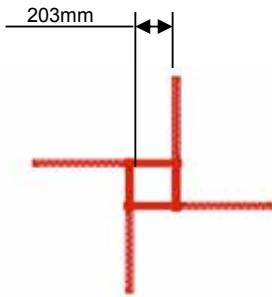

**Min Size**

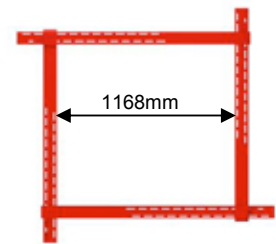
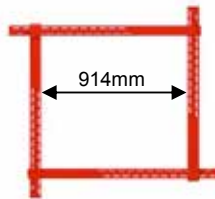
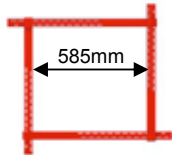

**Max Size**



**Column Clamps On Econo-Form  
Panel Column Box**

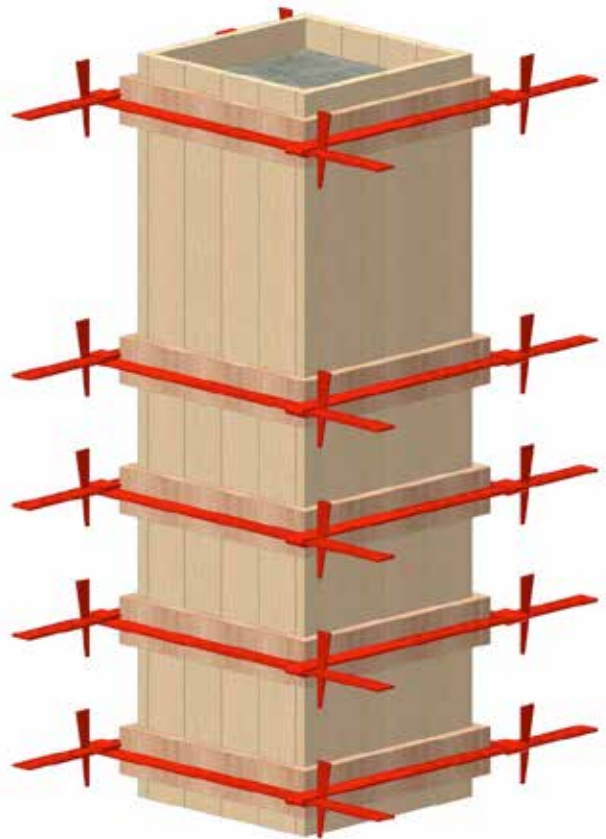

**Column Clamps On Timber Column Box**

## HEAD OFFICE

P.O. Box 669, Isando, 1600  
181 Barbara Road, Elandsfontein  
Tel 011 842-4000  
Fax 011 842-4280

## INLAND BRANCHES

### BLOEMFONTEIN

P.O. Box 6610, Bloemfontein, 9300  
26 Tibbie Visser Street, Estoire S/H District  
Tel 051 432-5555  
Fax 051 432-4477

### BURGERSFORT

P.O. Box 2918, Burgersfort, 1150  
Plot 2484, Ext 23 Dirk Winterbach  
Street, Burgersfort  
Tel 013 004-0200

### JOHANNESBURG EAST

P.O. Box 26994, Boksburg, 1462  
Tunney Road, Gate 3, Elandsfontein  
Tel 011 842-4215  
Fax 011 842-4111

### JOHANNESBURG - KYA SAND

P.O. Box 2884, Honeydew, 2040  
40 Homestead Avenue, Kya Sand  
Tel 011 708-2227  
Fax 011 708-1159

### KATHU

P.O. Box 1235, Kathu, 8446  
33 Kalk Street, Industrial Area, Kathu  
Tel 053 723-2194, Fax 053 723-1078

### KUSILE

P.O. Box 4466, Pretoria, 0001  
Kusile Power Station, Balmoral Road,  
Mpumalanga  
Tel 082 578-4638

### LEPHALALE

P.O. Box 7495, Onverwaght, 0557  
Rietspruit Plot 23, Portion 46  
Witkop Road, Lephalale  
Tel 014 763-7982, Fax 014 763-7982

### NELSPRUIT

P.O. Box 4485, Nelspruit, 1200  
Erf 379, Rocky Drift  
Tel 013 758-1036, Fax 013 758-1063

### POLOKWANE

P.O. Box 3979, Polokwane, 0700  
62 Goud Street, Laboria, Polokwane  
Tel 015 293-0450, Fax 015 293-0460

### PRETORIA

P.O. Box 4466, Pretoria, 0001  
Park Lane North, Highway  
Business Park, Rooihuiskraal  
Tel 012 621-9900, Fax 012 621-9931

### RUSTENBURG

P.O. Box 6996, Rustenburg, 0300  
3 Ferro Street, Rustenburg  
Tel 014 538-2540, Fax 014 538-0087

### SECUNDA

P.O. Box 3781, Secunda, 2302  
1 Winkelhaak Road, McGill Ext, Evander  
Tel 017 632-4230, Fax 017 632-4234

### VEREENIGING

P.O. Box 1010, Vereeniging, 1930  
Cnr Telford & Van Riebeeck Street,  
Duncanville  
Tel 016 455-1611, Fax 016 455-1566

### WITBANK

P.O. Box 3869, Witbank, 1035  
TP66 Geodesic Cres. Mareden Ext. 3,  
Techno Park, Witbank  
Tel 013 690 1533, Fax 013 656-3713

## COASTAL BRANCHES

### BALLITO

P.O. Box 715, Umhlali, 4390  
Labora Terra Industrial Park,  
Shakas Rock Road, Ballito  
Tel 032 947-9430 Fax 032 947-0583

### CAPE TOWN

P.O. Box 37068, Chempet, 7442  
6 Drill Avenue, Montague Gardens  
Tel 021 528-6500  
Fax 021 551-1743

### DURBAN SOUTH

P.O. Box 485, Umbogintwini, 4120  
16 Stroude Place, Ispingo  
Tel 031 902-2677  
Fax 031 902-2771

### EAST LONDON

P.O. Box 2734, Beacon Bay, 5205  
5 Ray Craib Crescent, Beacon Bay  
Tel 043 748-2558  
Fax 043 748-3691

### GEORGE

P.O. Box 218, Hartenbos, 6520  
Cnr Albert Street & Bridge Road, George  
Tel 044 695-0294, Fax 044 695-1040

### KZN REGIONAL OFFICE

P.O. Box 33, New Germany, 3620  
178-180 Old Main Road, Pinetown  
Tel 031 713-9700 Fax 031 713-9715

### MARGATE

P.O. Box 1171, Margate, 4275  
Industrial Road, Margate  
Tel 039 317-1708, Fax 039 317-4073

### NEWCASTLE

P.O. Box 906, Newcastle, 2940  
22 Schonland Street, Industrial Sites  
Tel 034 375-7697, Fax 034 375-6935

### PIETERMARITZBURG

P.O. Box 21946, Mayors Walk, 3208  
Market Road Ext, Mkondeni  
Tel 033 346-1767, Fax 033 346-1753

### PORT ELIZABETH

P.O. Box 2112, North End, 6056  
4 Kendle Street, Neave Industrial Area  
Tel 041 453-2317, Fax 041 453-2524

### RICHARDS BAY

P.O. Box 1333, Richards Bay, 3900  
111 Alumina Alley, Alton Industrial North  
Tel 035 751-1140, Fax 035 751-1094

### STRAND

P.O. Box 1654, Somerset West, 7129  
Chilwan Crescent  
Helderberg, Industrial Park  
Tel 021 845-4090, Fax 021 845-4091

## INTERNATIONAL BRANCHES

### INTERNATIONAL SALES

P.O. Box 669, Isando, 1600  
181 Barbara Road, Elandsfontein  
Tel 011 842-4000,  
Fax 011 388 4550

### CHILE - COPIAPO

Rio Copiapo, 1949  
Plaza Comercio 2, Modulo 8 –  
Panamericana Norte, Copiapo, Chile  
Tel +565 254 1561

### CHILE - SANTIAGO

Cerro Portezuelo, 9801  
Parque Industrial Portezuelo,  
Quilicura, Santiago de Chile  
Tel +562 738-5019, Fax +562 738-6521

### GHANA - ACCRA

Plot L16, Accra Tema Motorway,  
Off Spintex Road,  
Motorway Industrial Area,  
Accra, Ghana  
Cell +27 82 829 6627

### MAURITIUS - PORT LOUIS

P.O. Box 748, Bell Village,  
Port Louis Western  
Plaine Lauzun Industrial Estate  
Tel +230 211-039, Fax +230 211-0392

### MOZAMBIQUE – PEMBA

Rua Estrada Nacional 106  
Muxara, Pemba  
Tel: +258 84 714 3142

### NAMIBIA - SWAKOPMUND

P.O. Box 2484, Swakopmund,  
36 Hidipo Hamutenya Street, Swakopmund  
Tel +26464 46-2020, Fax +26464 46- 2050

### NAMIBIA - WINDHOEK

P.O. Box 20286, Windhoek, 9000  
5 Nickel Street, Prosperitas  
Tel +26461 23-3693, Fax +26461 23-3272

### SWAZILAND - MATSAPHA

P.O. Box C1769, The Hub, Manzini M200,  
Swaziland Lot 814 King Mswati III Avenue,  
Swaziland, Matsapha  
Tel +268 2518 8360, Fax +27 12 349 9871

### ZAMBIA - KITWE

Karibu Business Park. Kitwe / Ndola  
Dual Carriageway, Kitwe  
Tel +26096 6880009 / +26095 5593676  
Cel +260966 923 854



**Technical Advice Centre 0800 20 50 29 / 011 842-4011**

**WACO AFRICA / HEAD OFFICE:** PO Box 669, Isando, 1600. 181 Barbara Road, Elandsfontein. Tel 011 842-4000, Fax 011 842-4280

[www.formscaff.com](http://www.formscaff.com)